

Panasonic®

DVD/CD PLAYER

Operating Instructions

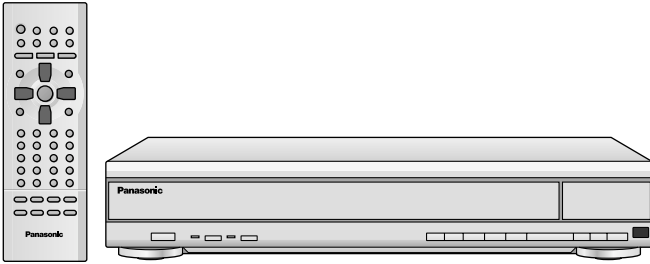

Model No. **DVD-CP72**



Before connecting, operating or adjusting this product, please read these instructions completely. Please keep this manual for future reference.



As an ENERGY STAR® Partner, Panasonic has determined that this product meets the ENERGY STAR® guidelines for energy efficiency.



This manual was printed with soy based ink.

Region number supported by this player

Region numbers are allocated to DVD players and software according to where they are sold.

- The region number of this player is “1”.
- The player will play DVD-Video marked with labels containing “1” or “ALL”.

Example:



The warranty can be found on page 26.

En la página 27 hay una guía de referencia rápida en español.

RQT6263-P

Dear customer

Thank you for purchasing this product. For optimum performance and safety, please read these instructions carefully.

Operations in these instructions are described mainly with the remote control, but you can do the operations on the main unit if the controls are the same.

Getting started

Accessories



Please check and identify the supplied accessories. Use numbers indicated in parentheses when asking for replacement parts.

To order accessories contact 1-800-332-5368 or web site (<http://www.panasonic.com>).

- 1 Remote control (N2QAJB000052)



- 2 Batteries for remote control

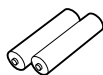

- 1 Audio/video cable (K2KA6CA00001)

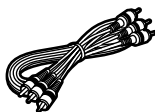

- 1 AC power supply cord (RJA0065-A)



Note

The included AC power supply cord is for use with this unit only. Do not use it with other equipment.

User memo:

DATE OF PURCHASE _____
 DEALER NAME _____
 DEALER ADDRESS _____
 TELEPHONE NUMBER _____

The model number and serial number of this product can be found on either the back or the bottom of the unit. Please note them in the space provided below and keep for future reference.

MODEL NUMBER _____ DVD-CP72
 SERIAL NUMBER _____

Table of contents

Getting started

Accessories	2
IMPORTANT SAFETY INSTRUCTIONS	4
Maintenance	4
Disc information	5
Connection	6
Connection to a television	6
Home Theater—Enjoying more powerful sound	7
Control reference guide	8
The remote control	8
Quick setup	9

Basic operations

Basic play	9
Disc type information screen	10
When a menu screen appears on the television	10
Changing the display on the main unit	10
Sequential Mode	10
Changing other discs during play	10
Changing the disc in the play position	10
Replaying a scene — QUICK REPLAY	10
Skipping items	11
Fast forward and rewind—SEARCH	11
Slow-motion play	11
Frame-by-frame viewing	11
Starting play from a selected item	11
Resume function	11
Selecting groups to play	12
Selecting still pictures—Page Skip	12
To enjoy even higher quality sound—AUDIO ONLY	12
Setting the unit to turn off — SLEEP timer	12
Using menus to play WMA/MP3 discs and CD text	13

Advanced operations

Playing the programs on DVD-RAM	14
Selecting a program to play—DIRECT NAVIGATOR	14
Using the play list menu	14
Convenient features	15
Changing soundtracks, subtitles and angles	15
4:3 TV ZOOM function	15
Program play	16
Random play	17
Repeat play	17
A-B repeat play	17
Using On-Screen Menu Icons	18
Common procedures	18
Disc information	18
Unit information	19
Progress indicator	20
Changing settings	21
Common procedures	22
Entering a password (Ratings)	22
Digital output	23
Speaker setting	23

Reference

Troubleshooting guide	24
Glossary	25
Limited Warranty	26
Customer Services Directory	26
Product Service	26
Guía de referencia rápida en español	27
(Spanish Quick Reference)	
Specifications	Back cover

CAUTION!

THIS PRODUCT UTILIZES A LASER.
USE OF CONTROLS OR ADJUSTMENTS OR PERFORMANCE OF PROCEDURES OTHER THAN THOSE SPECIFIED HEREIN MAY RESULT IN HAZARDOUS RADIATION EXPOSURE.
DO NOT OPEN COVERS AND DO NOT REPAIR YOURSELF. REFER SERVICING TO QUALIFIED PERSONNEL.

WARNING:

TO REDUCE THE RISK OF FIRE, ELECTRIC SHOCK OR PRODUCT DAMAGE, DO NOT EXPOSE THIS APPARATUS TO RAIN, MOISTURE, DRIPPING OR SPLASHING AND THAT NO OBJECTS FILLED WITH LIQUIDS, SUCH AS VASES, SHALL BE PLACED ON THE APPARATUS.

CAUTION:

This equipment has been tested and found to comply with the limits for a Class B digital device, pursuant to Part 15 of the FCC Rules.

These limits are designed to provide reasonable protection against harmful interference in a residential installation. This equipment generates, uses and can radiate radio frequency energy and, if not installed and used in accordance with the instructions, may cause harmful interference to radio communications. However, there is no guarantee that interference will not occur in a particular installation. If this equipment does cause harmful interference to radio or television reception, which can be determined by turning the equipment off and on, the user is encouraged to try to correct the interference by one or more of the following measures:

- Reorient or relocate the receiving antenna.
- Increase the separation between the equipment and receiver.
- Connect the equipment into an outlet on a circuit different from that to which the receiver is connected.
- Consult the dealer or an experienced radio/TV technician for help.

Any unauthorized changes or modifications to this equipment would void the user's authority to operate this device.

This device complies with Part 15 of the FCC Rules. Operation is subject to the following two conditions:
(1) This device may not cause harmful interference, and
(2) this device must accept any interference received, including interference that may cause undesired operation.



CAUTION

**RISK OF ELECTRIC SHOCK
DO NOT OPEN**



CAUTION: TO REDUCE THE RISK OF ELECTRIC SHOCK, DO NOT REMOVE SCREWS. NO USER-SERVICEABLE PARTS INSIDE.
REFER SERVICING TO QUALIFIED SERVICE PERSONNEL.



The lightning flash with arrowhead symbol, within an equilateral triangle, is intended to alert the user to the presence of uninsulated "dangerous voltage" within the product's enclosure that may be of sufficient magnitude to constitute a risk of electric shock to persons.



The exclamation point within an equilateral triangle is intended to alert the user to the presence of important operating and maintenance (servicing) instructions in the literature accompanying the appliance.

DANGER	- VISIBLE AND INVISIBLE LASER RADIATION WHEN OPEN. AVOID DIRECT EXPOSURE TO BEAM. (FDA 21 CFR)
CAUTION	- VISIBLE AND INVISIBLE LASER RADIATION WHEN OPEN. AVOID EXPOSURE TO BEAM. (IEC60825-1)
ATTENTION	- RAYONNEMENT LASER VISIBLE ET INVISIBLE EN CAS D'OUVERTURE. EXPOSITION DANGEREUSE AU FASCEAU
ADVARSEL	- SYNLIG OG USYNLIG LASERSTRÅLING VED ÅBNING. UNNGÅ UDSÆTTELSE FOR STRÅLING.
VARO!	- AVATTAESSA OLET ALTTIINA NÄKYVÄÄ JA NÄKYMÄTÖN LASERSÄTEILYLLE. ÄLÄ KATSO SÄTEESEEN.
VARNING	- SYNLIG OCH OSYNLIG LASERSTRÅLNING NÄR DENNA DEL ÄR ÖPPNAD. BETRÄKTA EJ STRÅLEN.
ADVARSEL	- SYNLIG OG USYNLIG LASERSTRÅLING NÄR DEKSEL ÅPNES. UNNGÅ EKSPONERING FOR STRÅLEN.
VORSICHT	- SICHTBARE UND UNSICHTBARE LASERSTRAHLUNG, WENN ABDECKUNG GEOFFNET. NICHT DEM STRAHL AUSSETZEN.
注意	- 打开时有可见及不可见激光辐射。避免激光束照射。
注意	- ここを開くと可視及び不可視のレーザー光が出ます。 ビームを直接見たり、触れたりしないでください。 RQLS0233

(Inside of product)

IMPORTANT SAFETY INSTRUCTIONS

Read these operating instructions carefully before using the unit. Follow the safety instructions on the unit and the safety precautions listed below. Keep these operating instructions handy for future reference.

Safety

1. **Power source**—Connect the unit to a power source of the type described in these instructions or as marked on the unit.
2. **Polarization**—The unit is equipped with a polarized power plug where one blade is wider than the other. This safety feature ensures that the plug fits into your household AC outlet only one way. If the plug doesn't fit one way, try reversing it. If the plug still doesn't fit, contact an electrician to replace the obsolete outlet. Do not attempt to defeat the safety purpose of the plug.
3. **Power cord protection**—Route the AC power supply cord so that it will not be walked on or pinched by items placed on or against it. Never take hold of the plug or cord with wet hands. Always grasp the plug body firmly when connecting and disconnecting it.
4. **Overloading**—When connecting the AC power supply cord, be careful not to overload the household AC outlet, extension cord, or outlet from any other device as this can result in fire or electric shock.
5. **Nonuse periods**—Turn the unit off when it is not in use. Unplug the unit from the household AC outlet if it is not to be used for a long time. Unplug the unit during lightning storms.
6. **Attachments and accessories**—Use only the attachments and accessories recommended in these operating instructions.

Installation

Placement

1. **Ventilation**—Situate the unit so that it receives proper ventilation. Do not install in a confined space such as a bookcase or cabinet. Allow at least 10 cm (4 inches) clearance from the rear of the unit. To prevent the risk of electric shock or fire due to overheating ensure curtains and other materials do not obstruct the unit's ventilation.
2. **Foreign material**—Ensure objects and liquids do not get into the unit. Avoid exposing the unit to excessive smoke, dust, mechanical vibration, and shock.
3. **Magnetism**—Situate the unit away from equipment and devices that generate strong magnetic fields.
4. **Stacking**—Do not place heavy objects on top of this unit.
5. **Surface**—Place the unit on a flat, level surface.
6. **Carts and stands**—Use the unit only with carts and stands recommended by the manufacturer. Move carts with care. Sudden stops, excessive force, and uneven surfaces can cause carts to overturn.
7. **Wall and ceiling mounting**—Do not mount the unit on walls or ceilings unless specified in the instructions.



Do not place the unit on amplifiers or equipment that may become hot.

The heat can damage the unit.

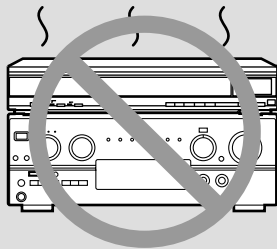

Environment

1. **Water and moisture**—Do not use the unit near water, such as near a bathtub or swimming pool. Avoid damp basements.
2. **Heat**—Situate the unit away from heat sources, such as radiators. Do not situate where temperatures fall below 5°C (41°F) or rise above 35°C (95°F).

Maintenance

(See below for details.)

Unplug the unit from the household AC outlet before cleaning. Clean with a damp cloth. Do not use abrasive pads, scouring powders, or solvents.

Service

1. **Damage requiring service**—The unit should be serviced by qualified service personnel if:
 - (a) The AC power supply cord or the plug has been damaged; or
 - (b) Objects or liquids have gotten into the unit; or
 - (c) The unit has been exposed to rain; or
 - (d) The unit does not operate normally or exhibits a marked change in performance; or
 - (e) The unit has been dropped or the cabinet damaged.
2. **Servicing**—Do not attempt to service the unit beyond that described in these operating instructions. Refer all other servicing to authorized servicing personnel.
3. **Replacement parts**—When parts need replacing ensure the servicer uses parts specified by the manufacturer or parts that have the same characteristics as the original parts. Unauthorized substitutes may result in fire, electric shock, or other hazards.
4. **Safety check**—After repairs or service, ask the servicer to perform safety checks to confirm that the unit is in proper working condition.

Before moving the unit, ensure the disc trays are empty.

Failure to do so will risk severely damaging the discs and the unit.

Maintenance

To clean this unit, wipe with a soft, damp cloth.

- Never use alcohol, paint thinner or benzene to clean this unit.
- Before using chemically treated cloth, read the instructions that came with the cloth carefully.

■ Discs that can be played

Disc type	Logo	Indication in these operating instructions
DVD-RAM		RAM Shown as "DVD-VR" on the display
DVD-Audio		DVD-A
DVD-Video		DVD-V
DVD-R		
Video CD		VCD
CD		CD Including CD-R/RW
	—	WMA Discs recorded with WMA
	—	MP3 Discs recorded with MP3

Do not use irregularly shaped discs (e.g. heart-shaped), as these can damage the unit.

■ Discs that cannot be played

PAL discs (the audio on DVD-Audio can be played), DVD-ROM, CD-ROM, CDV, CD-G, +RW, DVD-RW, CVD, SVCD, SACD, Divx Video Discs and Photo CD.

■ DVDs that can be played

You can play discs with these symbols.



■ Playing DVDs and Video CDs

The producer of these discs can control how they are played so you may not always be able to control play as described in these operating instructions. Read the disc's instructions carefully.

■ CD-R and CD-RW discs

This unit can play CD-R and CD-RW if they are formatted as CD-DA (digital audio) or video CD and finalized*.

■ DVD-R discs

Panasonic DVD-R recorded and finalized* on a Panasonic DVD video recorder are played as DVD-Video on this unit.

*A process that allows play on compatible equipment.

■ DVD-RAM discs

DVD-RAM discs must meet the following conditions for this unit to be able to play them.

Type	<ul style="list-style-type: none"> • Non-cartridge discs • Discs that can be removed from their cartridges (TYPE 2 and 4)
Capacity	<ul style="list-style-type: none"> • 12 cm (5") 9.4 GB (double-sided) and 4.7 GB (single-sided) • 8 cm (3") 2.8 GB (double-sided)
Recording format	Discs recorded with DVD video recorders, DVD video cameras, personal computers, etc., using Version 1.1 of the Video Recording Format (a unified video recording standard).

- Remove TYPE 2 and 4 discs from their cartridges before use, then return them when you are finished. Read the instructions for the disc carefully.

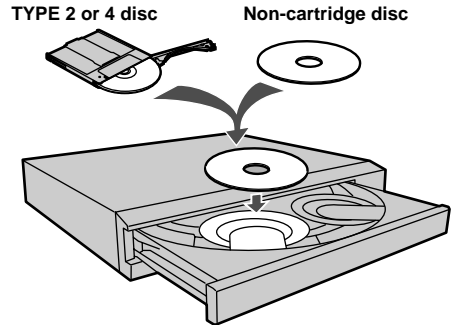

- Some parts of the disc, for example where one program ends and another begins, may not play smoothly.

Note

It may not be possible to play CD-R, CD-RW, DVD-R and DVD-RAM in all cases due to the type of disc or condition of the recording.

■ To clean discs

DVD-Audio, DVD-Video, Video CD, CD

Wipe with a damp cloth and then wipe dry.

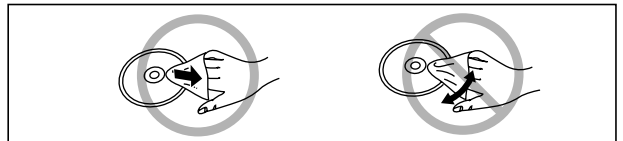

DVD-RAM, DVD-R

- Clean only with the DVD-RAM/PD disc cleaner available as an optional accessory (part number LF-K200DCA1).
- Never use cloths or cleaners for CDs etc.

■ Handling precautions

- Do not write on the label side with a ball-point pen or other writing instrument.
- Do not use record cleaning sprays, benzene, thinner, static electricity prevention liquids or any other solvent.
- Do not attach labels or stickers to discs. (Do not use discs with exposed adhesive from tape or left over peeled-off stickers.)
- Do not use scratch-proof protectors or covers.
- Do not use discs printed with label printers available on the market.

Connection to a television

This page explains how to connect the unit to a television and set it up so you hear the audio through the television's speakers. To get the full benefit from the powerful multi-channel audio found on DVDs, you should connect an amplifier and speakers (➔ page 7).

Before connection

- Disconnect the AC power supply cord.
- Refer to the television's operating instructions.

Connect your unit directly to your television.

Do not connect the unit through your video cassette recorder when setting up your home entertainment system, because the picture may not be played correctly due to the copy guard.

Conserving power

This unit consumes a small amount of power, even when it is turned off. (approx. 2.5 W)

To save power when the unit is not to be used for a long time, unplug it from the household AC outlet.

Getting started

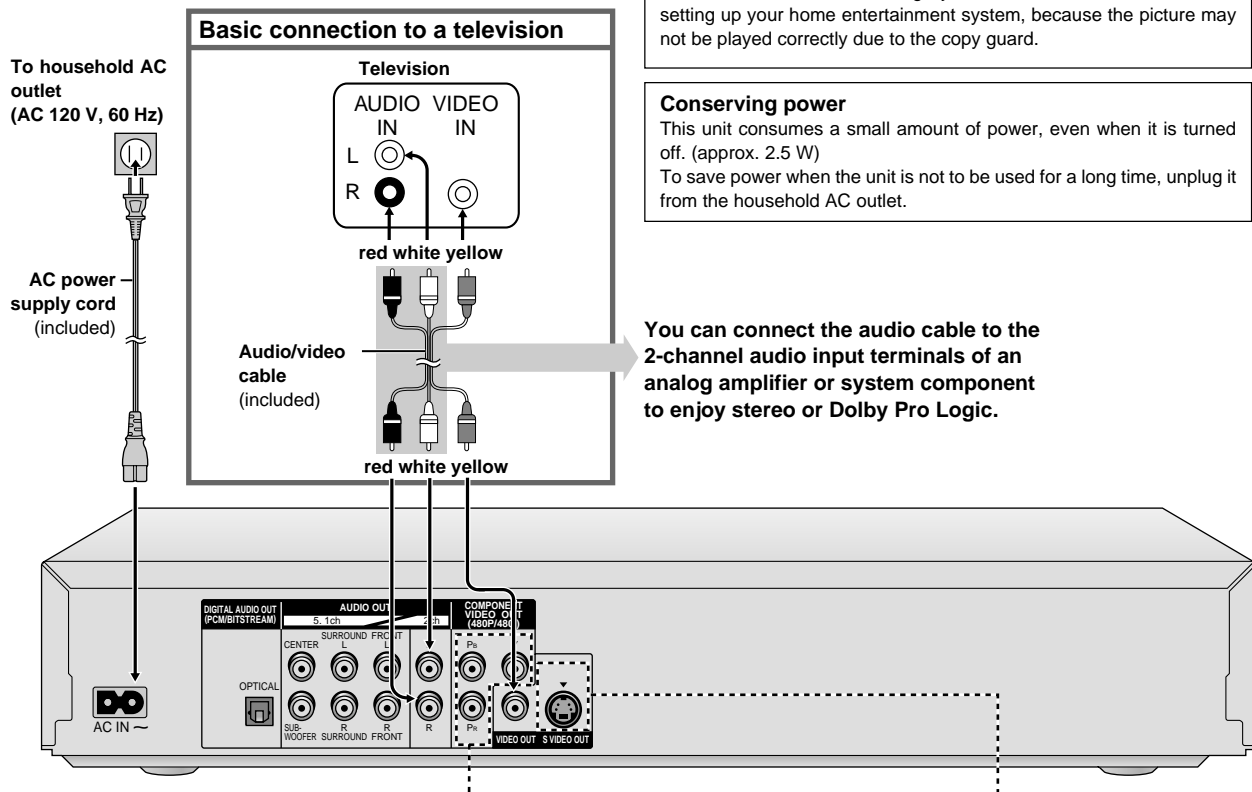

You can connect the audio cable to the 2-channel audio input terminals of an analog amplifier or system component to enjoy stereo or Dolby Pro Logic.

Enjoying higher picture quality

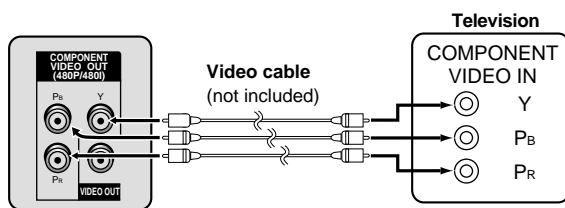

COMPONENT VIDEO OUT terminal

These terminals can be used for either interlace or progressive output and provide a purer picture than the S VIDEO OUT terminal. Connection using these terminals outputs the color difference signals (P_B/P_R) and luminance signal (Y) separately in order to achieve high fidelity in reproducing colors.

- The description of the component video input terminals depends on the television or monitor (e.g. Y/P_B/P_R, Y/B-Y/R-Y, Y/C_B/C_R). Connect to terminals of the same color.
- After making this connection, change the black level for a better picture. (➔ page 21, Video—Black Level Control)

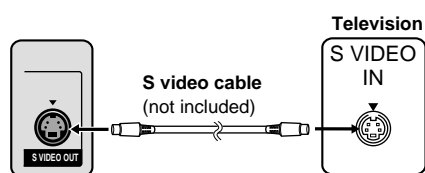

S VIDEO OUT terminal

The S video terminal achieves a more vivid picture than the VIDEO OUT terminal by separating the chrominance (C) and luminance (Y) signals. (Actual results depend on the television.)

When making this connection, ensure you connect the audio cables to the corresponding audio input terminals on the television.

To enjoy progressive video

- Connect to the component video (480P) input terminals on a television compatible with this unit's copy guard system. (Video will not be displayed correctly if connected to an incompatible television.)
- In QUICK SETUP, set "Progressive Out" to "Enable" (➔ page 9).

For your reference

- All televisions manufactured by Panasonic and that have 480P input connectors are compatible. Consult the manufacturer if you have another brand of television.

Home Theater—Enjoying more powerful sound

Enjoy the powerful movie theater and hall-like sound available with multiple channel audio found on DVDs by connecting an amplifier and speakers. There are two types of connection, digital and analog.

A Digital—Connect an amplifier with Dolby Digital and DTS decoders to enjoy surround sound.

You can also enjoy high-quality stereo sound with sampling frequencies of 88.2 and 96 kHz if the material isn't copy-protected and the equipment you connect is compatible with these signals.

Note

- The equipment connections described are examples.
- Peripheral equipment and optional cables sold separately unless otherwise indicated.
- Before connection, turn off all equipment and read the appropriate operating instructions.

B Analog—Connect an amplifier with multi-channel audio input terminals to enjoy surround sound.

This unit can decode Dolby Digital and DTS and there are no limitations on sampling frequency with this kind of connection.

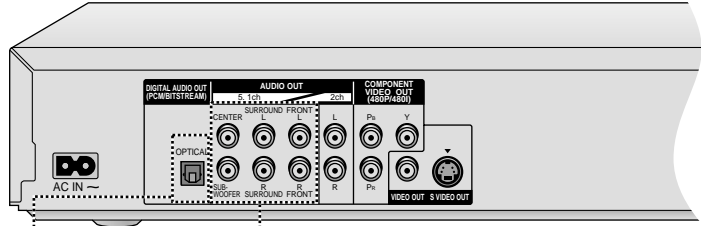

A Digital connection

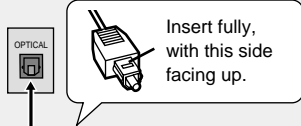

Optical digital audio cable
Do not bend sharply when connecting.

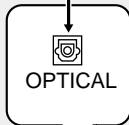

Change "Digital output" (⇒ page 23).

B Analog connection

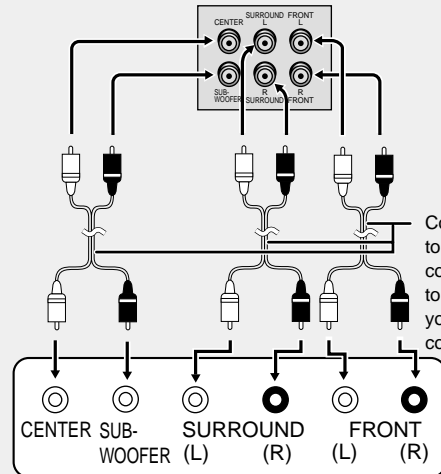

Connect cables to terminals corresponding to the speakers you have connected.

Change "Speaker setting" (⇒ page 23).

You can connect to a digital amplifier or system component to enjoy stereo or Dolby Pro Logic.

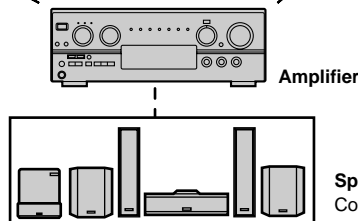

Speakers (example)

Connect three or more speakers for surround sound.

Note

- If you don't connect a subwoofer, it is advisable to connect front speakers (L/R) capable of producing bass of less than 100 Hz.
- You cannot use DTS Digital Surround decoders not suited to DVD-Video.

Recording

• **Digital recording** (⇒ Connection **A** above)

You can record the digital signal directly to digital recording equipment.

Note

- With DVD, the following conditions must be met: Ⓐ the disc doesn't have protection preventing digital recording, and Ⓑ the recording equipment can handle signals with a sampling frequency of 48 kHz.
- You cannot record WMA/MP3.

When recording DVDs, make the following settings.

- Advanced Surround (VSS): OFF (⇒ page 19)
- Digital Audio Output: On (⇒ page 21)
- PCM Down Conversion: Yes
- Dolby Digital/DTS Digital Surround: PCM (⇒ page 23)

• **Analog recording** (⇒ Connection **B** above)

You can record to a cassette deck or other recording equipment. There are no limitations on recording analog signals as there are with digital signals.

Control reference guide

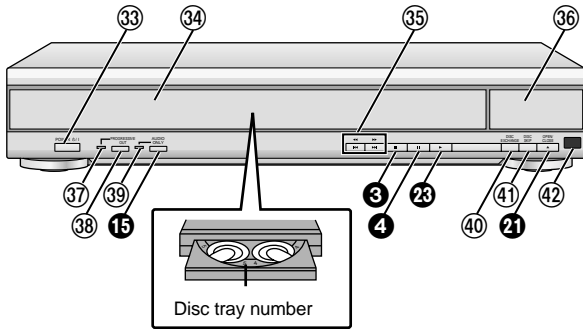
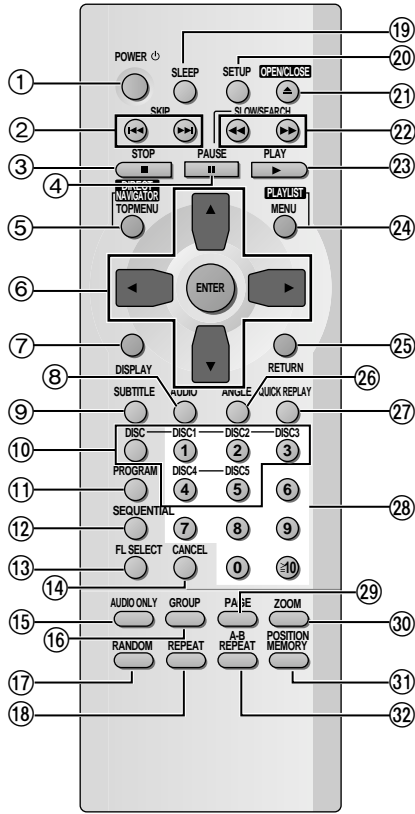

Buttons such as 32 function the same as the controls on the remote control.

	Page
1 Standby/on button (POWER ⏻)	9
2 Skip buttons (⏮, ⏭ SKIP)	11
3 Stop button (■ STOP)	9
4 Pause button (⏸ PAUSE)	9
5 Top menu, Direct navigator button (TOP MENU, DIRECT NAVIGATOR)	10, 14
6 Cursor buttons (▲, ▼, ◀, ▶), Enter button (ENTER)	9
7 Display button (DISPLAY)	18
8 Audio button (AUDIO)	15
9 Subtitle button (SUBTITLE)	15
10 Disc select button (DISC), Disc buttons (DISC 1 – DISC 5)	10
11 Program button (PROGRAM)	16
12 Sequential button (SEQUENTIAL)	10
13 FL select button (FL SELECT)	10
14 Cancel button (CANCEL)	12
15 Audio only button (AUDIO ONLY)	12
16 Group button (GROUP)	12
17 Random button (RANDOM)	17
18 Repeat button (REPEAT)	17
19 Sleep button (SLEEP)	12
20 Setup button (SETUP)	9, 22
21 Drawer open/close button (▲ OPEN/CLOSE)	9
22 Slow/Search buttons (⏮, ⏭ SLOW/SEARCH)	11
23 Play button (▶ PLAY)	9
24 Menu, Play list button (MENU, PLAY LIST)	10, 14
25 Return button (RETURN)	9
26 Angle button (ANGLE)	15
27 Quick replay button (QUICK REPLAY)	10
28 Numbered buttons (1–9, 0, ≥10)	10
29 Page button (PAGE)	12
30 4:3 TV zoom button (ZOOM)	15
31 Position memory button (POSITION MEMORY)	11
32 A-B repeat button (A-B REPEAT)	17
33 Standby/on switch (POWER ⏻/⏻)	9
Press to switch the unit from on to standby mode or vice versa.	
In standby mode, the unit is still consuming a small amount of power.	
34 Drawer	9
35 Skip, Search buttons (⏮, ⏭, ⏮, ⏭)	11
36 FL Display	10
37 Progressive out indicator	9
38 Progressive out button (PROGRESSIVE OUT)	9
39 Audio only indicator	12
40 Disc exchange button (DISC EXCHANGE)	10
41 Disc skip button (DISC SKIP)	10
42 Remote control signal sensor	10

The remote control

Batteries

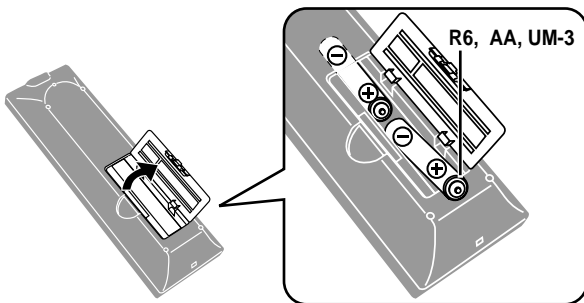

- Insert so the poles (+ and -) match those in the remote control.
- Do not use rechargeable type batteries.

Do not:

- mix old and new batteries.
 - use different types at the same time.
 - heat or expose to flame.
 - take apart or short circuit.
 - attempt to recharge alkaline or manganese batteries.
 - use batteries if the covering has been peeled off.
- Mishandling of batteries can cause electrolyte leakage which can damage items the fluid contacts and may cause a fire.

Remove if the remote control is not going to be used for a long period of time. Store in a cool, dark place.

Use

Aim at the sensor (➡ above, Control reference guide), avoiding obstacles, at a maximum range of 7 m (23 feet) directly in front of the unit.

Basic play

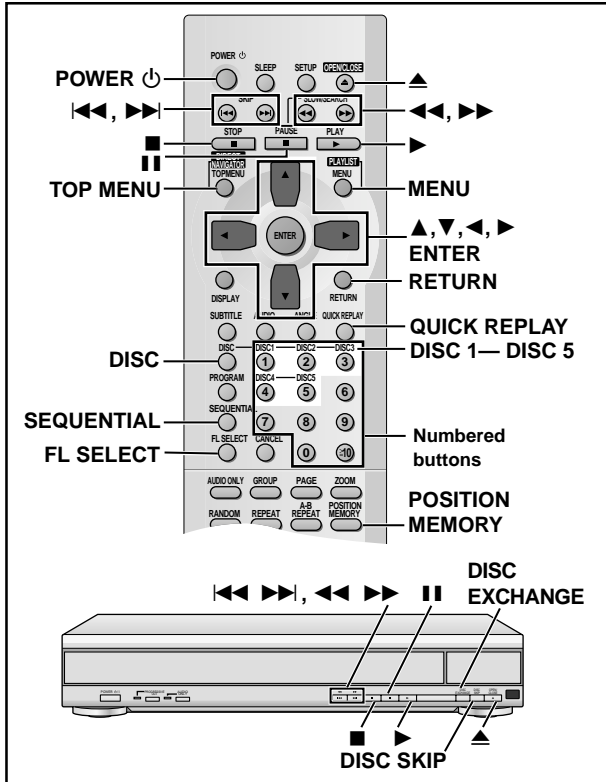

Disc type information screen

RAM DVD-A DVD-V VCD CD WMA MP3

You can check the kinds of discs loaded on the trays, and start playing the preferred disc.

1 Press [DISC].

Disc type information screen appears.

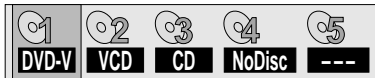

DVD-VR: DVD-RAM

VCD: Video CD

DVD-A: DVD-Audio

CD: Audio CD

DVD-V: DVD-Video

WMA/MP3: WMA/MP3 formatted CD

---: The unit has not determined the kind of the disc.

NoDisc: There is no disc on the tray.

2 Press the disc button ([DISC 1] – [DISC 5]).

The disc on the selected tray starts playing.

To clear the disc type information screen

Press [DISC].

Note

When you play a disc that contains both WMA and MP3 files, the unit displays the format of the track being played.

When a menu screen appears on the television

DVD-A DVD-V VCD

Press the numbered buttons to select an item.

To select a 2-digit number

e.g. 23: [≥10] → [2] → [3]

•When playing DVDs, you can also use [▲], [▼], [◀], [▶] to select items.

Press [ENTER] to confirm your selection.

Play of the selected item now begins.

Other buttons used to operate menus

Read the disc's instructions for further details about operation.

[▶▶]: Shows the next menu.

[◀◀]: Shows the previous menu.

[RETURN]: Shows the menu screen. VCD

[TOP MENU]: Shows the first menu screen. DVD-A DVD-V

[MENU]: Shows the menu screen. DVD-V

Changing the display on the main unit

RAM DVD-A DVD-V VCD CD WMA MP3

Press [FL SELECT].

Each time you press the button:

Program/Group/Title/Chapter/Track display

Time display



Sequential Mode

RAM DVD-A VCD CD WMA MP3

While stopped

Press [SEQUENTIAL].

Each time you press the button:

SEQ on: Plays all type of the discs (except DVD-Video) once each in turn.

- The playback control function on Video CDs is canceled.

SEQ off: Plays only one disc in the play position (This mode is on whenever you turn the unit on.)

Note

•This feature doesn't work during program/random play.

•If you turn Sequential Mode on during play:

—DVD-Video: Play will stop and start again with the next disc.

—Other discs: The unit will stop and then resume play from the beginning of the disc.

Changing other discs during play

RAM DVD-A DVD-V VCD CD WMA MP3

You can change the other discs without interrupting play.

Main unit only

During play

- 1 Press [▲] to open the drawer.
- 2 Press [DISC SKIP] to rotate the disc tray to the desired position.
The carousel will move clockwise by one disc tray. Then, each press moves the carousel in the opposite direction by two disc trays.
- 3 Change the disc and press [▲] to close the drawer.

Changing the disc in the play position

RAM DVD-A DVD-V VCD CD WMA MP3

Main unit only

During play or while stopped

1 Press [DISC EXCHANGE].

Play is stopped (if pressed during play), the drawer opens and the disc tray that was in the play position comes to the front-left position.

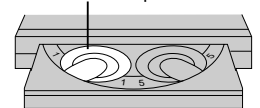

2 Change the disc in the front-left position.

3 Press [DISC EXCHANGE].

The drawer closes and play begins from the new disc.

Replaying a scene — QUICK REPLAY

RAM DVD-A DVD-V VCD CD WMA MP3

Skip back a few seconds within the current item (program, track or title).

During play

Press [QUICK REPLAY].

Note

This feature may not work while playing some parts of a disc or at all with some discs.

Skipping items

RAM DVD-A DVD-V VCD CD WMA MP3

You can skip chapters on DVD-Video, tracks on DVD-Audio, CDs and Video CDs, and on DVD-RAM you can skip to the start of a program, scene in a play list, or to a marker.

During play or while paused

Press [**◀◀**] or [**▶▶**].

Each press increases the number of skips.

Fast forward and rewind—SEARCH

RAM DVD-A DVD-V VCD CD WMA MP3

During play

Press [**◀◀**] or [**▶▶**].

- Press and hold [**◀◀**] or [**▶▶**] on the main unit.
- You may erase sound during search (⇒ page 21, Audio—Audio during Search).

Slow-motion play

RAM DVD-A DVD-V VCD

While paused

Press [**◀◀**] or [**▶▶**].

Press and hold [**◀◀**] or [**▶▶**] on the main unit.

Frame-by-frame viewing

RAM DVD-A DVD-V VCD

While paused

Press [**◀**] or [**▶**].

The frame changes each time you press the button.

- The frames change in succession if you press and hold the button.
- Pressing [**⏏**] also activates forward frame-by-frame.

Notes

- The speed of search and slow-motion increases up to 5 steps.
- Press [**▶**] (PLAY) to restart play.
- You cannot move backwards with Video CD during slow-motion and frame-by-frame.
- Slow-motion and frame-by-frame only work on the moving picture parts of DVD-Audio.
- **When playing Video CDs with playback control**
Pressing buttons to perform skip, search or slow-motion may take you to a menu screen.

Starting play from a selected item

RAM DVD-A DVD-V VCD CD WMA MP3

Press the numbered buttons to select the item.

To select a 2-digit number

e.g. 23: [**≥10**] ⇒ [**2**] ⇒ [**3**]

WMA MP3

Press [ENTER] after pressing the numbered buttons.

(You do not have to press [**≥10**].)

Play starts from the selected item.

Note

- This works only when stopped with some discs.
- When playing DVD-Audio and you want to start play from a track in a different group, select the group first (⇒ page 12).

Resume function

RAM DVD-A DVD-V VCD CD WMA MP3

(When the elapsed play time is displayed)

The position you stopped play at is recorded by the unit when “▷” is flashing on the display.



While “▷” is flashing, press [**▶**] (PLAY) to start play from where you stopped it. (When playing DVD-Video ⇒ Chapter Preview below)

- The position is cleared when the disc is changed or the unit is switched to standby.

To clear the position

Press [**■**] before recalling the memorized position.

Position Memory function

This function allows you to memorize a position to start from even after switching the unit to standby or changing discs. You can memorize positions on up to five different discs at a time. When you memorize another position, the earliest position is replaced.

- This function doesn't work;
 - while playing play lists on DVD-RAM.
 - while playing some DVDs.

1. During play, press [POSITION MEMORY].



Light as you memorize positions.

2. Press [POWER ⏻] to switch the unit to standby, or change the disc.
3. Press [**▶**] (PLAY) to begin playback from the memorized position (the position is cleared). If you return to a disc to play it back again, playback will begin automatically.
(When playing DVD-Video ⇒ Chapter Preview below)

To clear the position

Press [**■**] before recalling the memorized position.

Note

You cannot recall the memorized position in Sequential Mode.

Chapter Preview DVD-V

The message appears immediately after you press [**▶**] (PLAY).

Press PLAY to Preview Chapters

Press [**▶**] (PLAY) while the message is displayed and the beginning portions of each chapter up to the current one are played. Full play resumes from the point where you pressed [**■**] or [POSITION MEMORY]. (This feature works only within a title.)

If you do not press [**▶**] (PLAY), the message disappears and play starts from where you pressed [**■**] or [POSITION MEMORY].

Using menus to play WMA/MP3 discs and CD text

WMA **MP3**: This unit can play WMA (Windows Media Audio) and MP3 files recorded on CD-R/RW with a computer. Files are treated as tracks and folders are treated as groups.

CD (CD text): This unit reads and displays the information on CD text discs. You can display disc titles, artist names and track titles.

1 Press [TOP MENU].

e.g. MP3

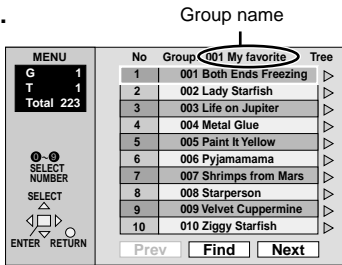

2 Press [▲, ▼] to select the track and press [ENTER].

Play continues to the last track in the last group.
"C" indicates the track currently playing.

To show other pages

Press [▲, ▼, ◀, ▶] to select "Prev" or "Next" and press [ENTER].
After listing all the tracks in one group, the list for the next group appears.

To exit the file list

Press [TOP MENU].

Note

- Discs must conform to ISO9660 level 1 or 2 (except for extended formats).
- This unit is compatible with multi-session but if there are a lot of sessions it takes more time for play to start. Keep the number of sessions to a minimum to avoid this.
- If you play an WMA/MP3 track that includes still picture data, it will take some time before the music itself starts playing and the elapsed time will not be displayed during this time. Even after the track starts, the correct play time will not be displayed.

WMA

- When creating a WMA disc, ensure the copyright feature is off.
- WMA files must have the extension ".WMA" or ".wma".
- Noise may occur when playing WMA files.
- There are some files this unit cannot play (e.g., copyright protected). "TRACK PROTECTED" or "CANNOT PLAY THIS TRACK" appear on the unit's display to indicate such tracks.

MP3

- MP3 files must have the extension ".MP3" or ".mp3".
- This unit is not compatible with ID3 tags.
- This unit is not compatible with files with a sampling rate of 32 kHz.

Naming folders and files

At the time of recording, prefix folder and file names with 3-digit numbers in the order you want to play them (this may not work at times).

CD (CD text)

When making your own CD text discs

The unit plays the tracks in the order you record them so you do not have to prefix the titles with numbers.

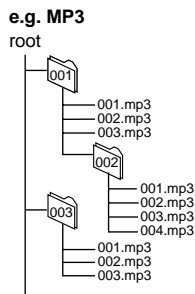

Windows Media, and the Windows logo are trademarks, or registered trademarks of Microsoft Corporation in the United States and/or other countries.

WMA is a compression format developed by Microsoft Corporation. It achieves the same sound quality as MP3 with a file size that is smaller than that of MP3.



Using the tree screen to find a group **WMA** **MP3**

1 Press [▶] while a track is highlighted to display the tree screen.

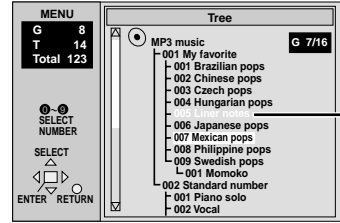

You cannot select groups that contain no compatible files.

2 Press [▲, ▼] to select a group and press [ENTER].

The file list for the group appears.

For your reference

Press [◀, ▶] to jump layers in the tree screen.

To return to the file list

Press [RETURN].

To show the text information for a track **CD** (CD text)

1 Press [▲, ▼] to select a track.

2 Press [▶] to show the text information.

- Press [◀, ▶] to select other tracks. Press [ENTER] to play tracks selected here.

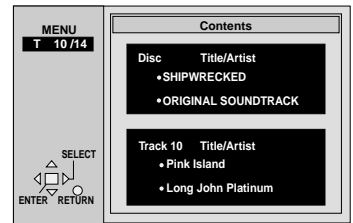

To return to the list screen

Press [RETURN].

Finding a track to play

Enter part of a track title to make a search. Although the characters are upper case, the unit also searches for lower case.

Example: search for tracks including the word "LOVE".

1 Press [▲, ▼] to select "Find" and press [ENTER].

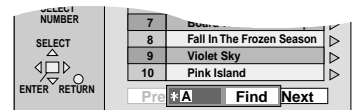

2 Press [▲, ▼] to select "L" and press [ENTER].

- Characters change in alphanumeric order each time you press [▲].
- Press [◀, ▶] to skip between A, E, I, O and U.
- Press [◀] to erase a character.
- Repeat this step to enter "O", "V", and "E".

3 Press [▶] to select "Find" and press [ENTER].

The search results screen appears.

4 Press [▲, ▼] to select the track and press [ENTER].

Press [▼] to show other tracks if there are more than fifteen.

- To search for the first word in a title, erase the asterisk (*) first.
- You can also enter numbers with the numbered buttons.

To return to the list screen

Press [RETURN].

Playing the programs on DVD-RAM

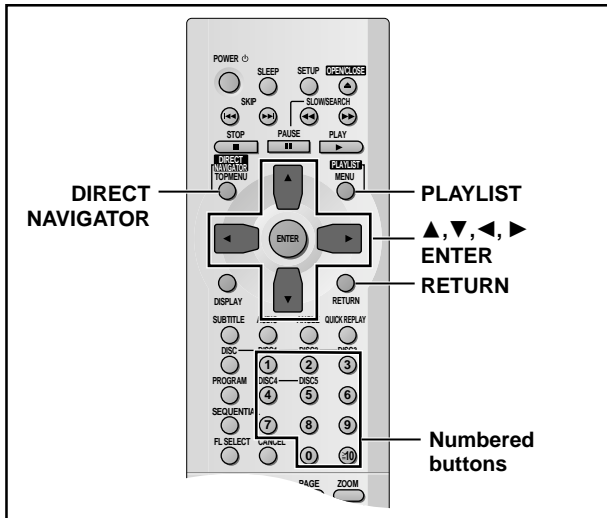

Using the play list menu

You can play a group of scenes, a play list, created on other equipment such as a DVD video recorder.

You can also specify a scene to play.

Note

Play lists doesn't work in Sequential Mode.

Playing a play list

1 Press [PLAY LIST].

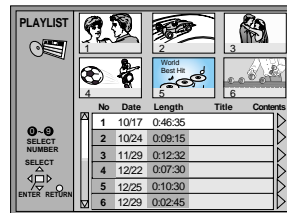

2 Press [▲, ▼] to select the play list.

- Press [▼] to show other play lists if there are more than six.

- You can select play lists with the numbered buttons.

To select a 2-digit number

e.g. 23: [≥10] → [2] → [3]

3 Press [ENTER] to start play.

To clear the play list screen

Press [PLAY LIST].

(The unit returns to the condition it was in before you called up the play list.)

To display information about a selected play list

1. Select the play list and press [▶].

2. Press [▲, ▼] to select "Contents" and press [ENTER].

Press [◀, ▶] to show other play lists.

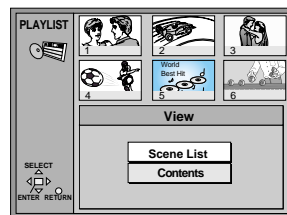

To return to the previous screen

Press [RETURN].

Playing a specific scene

1 Press [PLAY LIST].

2 Press [▲, ▼] to select the play list.

- You can select play lists with the numbered buttons.

To select a 2-digit number

e.g. 23: [≥10] → [2] → [3]

3 Press [▶].

4 Press [▲, ▼] to select "Scene List" and press [ENTER].



Page Total pages

5 Press [▲, ▼, ◀, ▶] to select a scene and press [ENTER].

- If there are more than 9 scenes, press [▲, ▼, ◀, ▶] to select "Next" and press [ENTER]. Select "Prev" to move back.

- You can also select a page with the numbered buttons.

To select a number

e.g. 23: [2] → [3] → [ENTER] (You do not have to press [≥10].)

To return to the previous screen

Press [RETURN].

RAM

Selecting a program to play —DIRECT NAVIGATOR

Use the program list to find programs to play.

Note

DIRECT NAVIGATOR doesn't work in Sequential Mode.

1 Press [DIRECT NAVIGATOR].

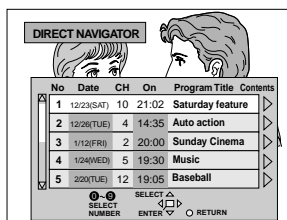

2 Press [▲, ▼] to select the program.

The selected program plays in the background.

- Press [▼] to show other programs if there are more than five.

- You can select programs with the numbered buttons.

To select a 2-digit number

e.g. 23: [≥10] → [2] → [3]

3 Press [ENTER].

The program being played in the background continues.

To clear the program list

Press [DIRECT NAVIGATOR].

(The unit returns to the condition it was in before you called up the program list.)

To display information about a selected program

Select the program and press [▶]. (The background picture pauses.)

Press [◀, ▶] to show the other programs.

To return to the previous screen

Press [RETURN].

Note

- Titles appear only if you have entered them.

- You cannot change program and disc titles.

Convenient features

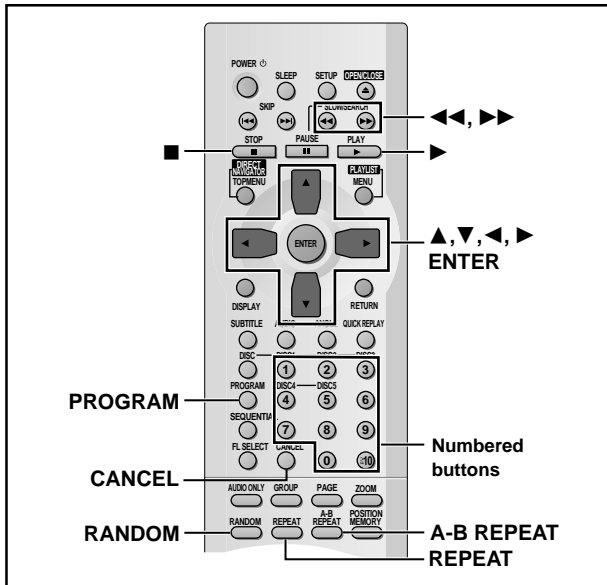

When Sequential Mode is off

RAM DVD-A DVD-V VCD CD WMA MP3

You can program all the items on a disc in the play position.

While stopped

1 Press [PROGRAM].

2 **DVD-A DVD-V WMA MP3**

Press the numbered buttons to select a group (**DVD-A WMA MP3**) or title (**DVD-V**).

•Some items cannot be selected.

3 Press the numbered buttons to select a program (RAM), a track (DVD-A VCD CD WMA MP3) or chapter (DVD-V), (WMA MP3 and press [ENTER]).

•Repeat steps 2 and 3 to program other items.

WMA MP3

•Select "ALL" using [**▲**, **▼**] to enter all items (on the disc or in the group).

VCD CD

•Press [ENTER] and [**▲**, **▼**] to select "ALL".

4 Press [▶] (PLAY).

•Some items will not be played even if you programmed them. **DVD-V**

Note

You cannot program if there is no disc on the tray in the play position.

Program play

You can select up to 32 items to play in the order you choose.

When Sequential Mode is on

RAM DVD-A VCD CD WMA MP3

You can program all the items on discs.

While stopped

1 Press [PROGRAM].

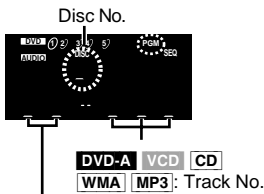

RAM: Program No.

DVD-A WMA MP3: Group No.

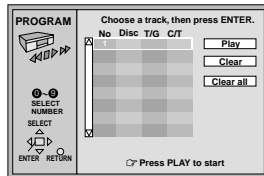

2-1 Press the numbered buttons to select a disc.

-2 DVD-A WMA MP3

Press the numbered buttons to select a group.

3 Press the numbered buttons to select a program (RAM) or a track (DVD-A VCD CD WMA MP3), (WMA MP3 and press [ENTER]).

•Repeat steps 2 and 3 to program other items.

4 Press [▶] (PLAY).

Play now begins in the programmed sequence.

Note

•You may be able to enter DVDs, empty trays, and item numbers for items not recorded on discs, but they are not played.

•If the chapter or track number flashes after entering it with the numbered buttons, press [ENTER] to continue to the next item.

To select using the cursor buttons

Press [ENTER] and [**▲**, **▼**] to select an item, then press [ENTER] again to register.

Changing the program

Press [**▲**, **▼**] to select an item.

—To change an item, repeat steps 2 and 3.

—To clear an item, press [CANCEL] (or select "Clear" and press [ENTER]).

Press [**◀◀**] or [**▶▶**] to change pages.

To exit the program mode

Press [PROGRAM] while stopped.

To clear the whole program

Move to "Clear all" with [**▲**, **▼**, **◀**, **▶**] and press [ENTER]. The whole program is also cleared when the disc is moved out of the play position while the sequential mode is off or the unit is turned off.

For your reference

You can program bonus groups as long as your password is accepted (→ page 12).

Random play

When Sequential Mode is on

RAM DVD-A VCD CD WMA MP3

You can play all discs (except DVD-Video) in random order.

While stopped

1 Press [RANDOM].

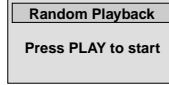

2 Press [▶] (PLAY).

Note

DVD-Video and empty trays are skipped during random play.

When Sequential Mode is off

RAM VCD CD WMA MP3

You can play all the items on a disc in the play position in random order.

DVD-A DVD-V

You can play selected item(s) on a disc in the play position in random order.

While stopped

1 Press [RANDOM].

2 [DVD-A] [DVD-V]

Press the numbered buttons to select a group (DVD-A) or a title (DVD-V).

DVD-A

- You can select more than one group. Select "All" using [◀, ▶] to enter all groups, and press [ENTER] to register.
- To deselect a group, press the numbered buttons corresponding to the group you want to clear.

DVD-V

- Some titles cannot be selected.

3 Press [▶] (PLAY).

To exit the random mode

Press [RANDOM] while stopped.

Note

- The playback control function on Video CDs is canceled.
- As long as your password is accepted, bonus groups can be played during random play (⇒ page 12).

RAM DVD-A DVD-V VCD CD WMA MP3

(When the elapsed play time is displayed)

Repeat play

During play

Press [REPEAT].

The indication changes each time you press the button:

RAM	DVD-A	WMA	MP3	DVD-V	VCD	CD
Program* ¹	Track* ¹	Disc* ²	Title* ²	Chapter* ¹	Track* ¹	Disc* ²
Disc* ²	Disc* ²	Disc* ²	Disc* ²	Title* ²	Disc* ²	Disc* ²
Sequential* ³	Sequential* ³	Sequential* ³	Sequential* ³	Off	Sequential* ³	Sequential* ³
Off	Off	Off	Off	Off	Off	Off
Scene* ⁴	Off	Off	Off	Off	Off	Off
Playlist* ⁴	Off	Off	Off	Off	Off	Off

e.g. DVD-Video

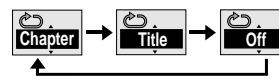

*1"1 Step" during program play.

*2"All" during program and random play when Sequential Mode is off.

*3 Only when Sequential Mode is on.

*4 During play list play. "Playlist" is not displayed while playing a specific play list scene.

*5 "Group" when Sequential Mode is off.

If the Video CD has playback control

1. Press [■] to clear "PBC" from the display.
2. Press the numbered buttons to select a track to start play (⇒ page 11).
3. Press [REPEAT] (⇒ above).

Note

You cannot use repeat play to repeat an entire DVD-Video, an entire WMA/MP3 disc or all the play lists on a DVD-RAM.

To repeat only your favorite programs/tracks / chapters

RAM DVD-A DVD-V VCD CD WMA MP3

Start program play (⇒ page 16) and press [REPEAT] to display "All".

A-B repeat play

You can repeat a section between points A and B within a program, title or track.

During play

- 1 Press [A-B REPEAT] at the starting point (A).
- 2 Press [A-B REPEAT] at the finishing point (B).



To cancel

Press [A-B REPEAT] to display "**".

Note

- Some subtitles recorded around point A or B may fail to appear. DVD-V
- The unit automatically determines the end of a program/title/track as point B when the end of the program/title/track is reached.
- A-B repeat is canceled when you press [QUICK REPLAY].

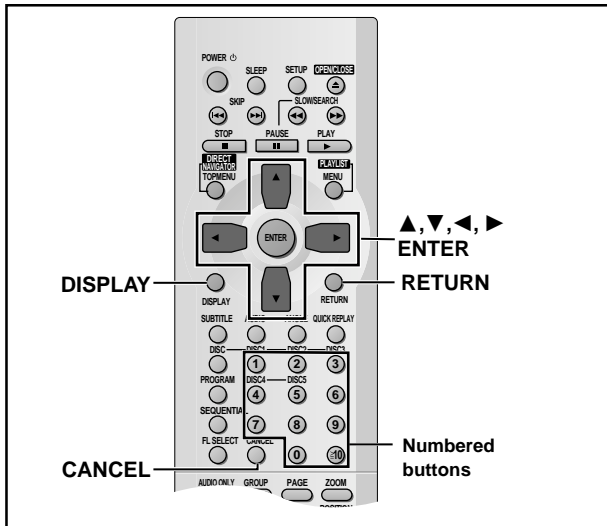

RAM DVD-A DVD-V VCD CD WMA MP3

On-Screen Menu Icons are menus that contain information about the disc or unit. These menus allow you to perform operations by changing this information.

Common procedures

- 1 Press [DISPLAY].
Each time you press the button:
Disc information (⇒ right) → Progress indicator (⇒ page 20)
Original display ← Unit information (⇒ pages 19–20)
- 2 **Unit information only**
While the leftmost icon is highlighted
Press [▲, ▼] to select the menu.
Each time you press the button:
Play Menu ↔ Picture Menu
Display Menu ↔ Audio Menu
- 3 Press [◀, ▶] to select the item.
- 4 Press [▲, ▼] to select the setting.
 - Items with “▲” or “▼” above and below can be changed by [▲, ▼].
 - Press [ENTER] if the setting does not change after pressing [▲, ▼].
 - Some items require different operations. Read the following explanations.

For your reference

- Depending on the condition of the unit (playing, stopped, etc.) and the type of software, there are some items that you cannot select or change.
- When numbers are displayed (e.g. title No.), the numbered buttons are also effective for setting. Press [ENTER] to register the setting.

To clear the menus

Press [RETURN] until the menus disappear.

To change the position of the icons

1. Press [◀, ▶] to select the Bar Position icon.
2. Press [▲, ▼] to move the icons. (There are 5 positions.)



Disc information

e.g. DVD-Video

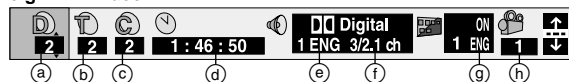

e.g. WMA/MP3 disc

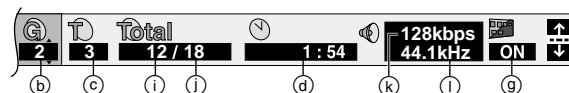

e.g. Video CD

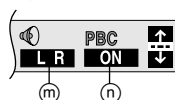

e.g. DVD-Audio

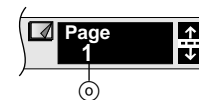

(a) D: Disc number RAM DVD-A DVD-V VCD CD WMA MP3

(b) PG: Program number RAM

PL: Play list number RAM

T: Title number DVD-V

Track number VCD CD

G: Group number DVD-A WMA MP3

(c) T: Track number in group DVD-A WMA MP3

C: Chapter number DVD-V

(d) Time RAM DVD-A DVD-V

- Press [▲, ▼] to show the elapsed play time or remaining time for the program, group, track or title (or chapter during program and random play).
- Select a position to start play by specifying a time with the numbered buttons and press [ENTER].

Changing the time display VCD CD

Press [▲, ▼] to show the elapsed play time, remaining time for the track, or remaining time for the disc.

Elapsed play time WMA MP3

(display only, cannot be changed)

(e) Soundtrack language DVD-A DVD-V (⇒ page 15)

(See [A] on page 19 for language abbreviations.)

(f) Audio signal type RAM DVD-A DVD-V (⇒ page 15)

(See [B] on page 19 for details.)

Karaoke vocal on/off (Karaoke DVD only) DVD-V

Solo: OFF or ON

Duet: OFF, V1 + V2, V1 or V2

(g) Subtitle language DVD-A DVD-V (⇒ page 15)

(See [A] on page 19 for language abbreviations.)

Subtitles on/off RAM DVD-A DVD-V

ON ↔ OFF

Track information on/off WMA MP3 CD (CD text)

ON ↔ OFF

(h) Angle number DVD-A DVD-V (⇒ page 15)

(i) Track number in disc WMA MP3

(j) Total number of tracks on disc WMA MP3

(k) Current bitrate WMA MP3

(l) Current sampling frequency WMA MP3

(m) Audio mode RAM VCD (⇒ page 15)

LR ↔ L ↔ R

↑ ↔ ↓

(n) Menu play VCD (with playback control only)

Indicates whether menu play (playback control) is on or off.

(o) Still picture number DVD-A

Selected picture is shown during play.

Unit information

Play Menu

e.g. DVD-Video

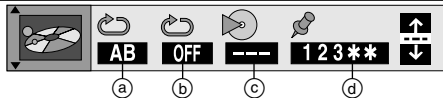

- a) **A-B Repeat** **RAM** **DVD-A** **DVD-V** **VCD** **CD** **WMA** **MP3** (→ page 17)
[ENTER] (start point) → [ENTER] (finish point)
To cancel: [ENTER]

- b) **Repeat Mode** (→ page 17)

RAM	DVD-A WMA MP3	DVD-V	VCD CD
Program*1	Track*1	Chapter*1	Track*1
Disc*2	Disc*2#5	Title*2	Disc*2
Sequential*3	Sequential*3	Off	Sequential*3
Off	Off	Off	Off
Scene*4			
Playlist*4			

*1"1 Step" during program play.

*2"All" during program and random play when Sequential Mode is off.

*3 Only when Sequential Mode is on.

*4 During play list play. "Playlist" is not displayed while playing a specific play list scene.

*5 "Group" when Sequential Mode is off.

- c) **Play mode display** **RAM** **DVD-A** **DVD-V** **VCD** **CD** **WMA** **MP3**
---: Normal play PGM: Program play RND: Random play

d) Marker

DVD-A **DVD-V** **VCD** **CD** **WMA** **MP3** : 5 positions
RAM : 999 positions

[ENTER] (The unit is now ready to accept markers.)

To mark a position: [ENTER] (at the desired point)

To mark another position: [◀, ▶] → [ENTER]

To recall a marker: [◀, ▶] → [ENTER]

To erase a marker: [◀, ▶] → [CANCEL]

RAM

To mark the eleventh point and beyond

1. [◀, ▶] to select the marker pin icon

2. [▲, ▼] to select "11-20"

You can select the next group when the current group is full.



- This feature doesn't work while using a play list.
- The markers are ordered by time. This means that the marker numbers can change when you add and erase markers.
- Markers placed using a recording device (e.g., DVD video recorder) will be displayed. While these may be erased temporarily, they will be redisplayed if the disc is changed or the unit is switched to standby.

Note

- This feature doesn't work during program and random play.
- All the markers are cleared when the disc is changed or the unit is switched to standby.

A Audio/Subtitle language

ENG: English	SVE: Swedish	CHI: Chinese
FRA: French	NOR: Norwegian	KOR: Korean
DEU: German	DAN: Danish	MAL: Malay
ITA: Italian	POR: Portuguese	VIE: Vietnamese
ESP: Spanish	RUS: Russian	THA: Thai
NLD: Dutch	JPN: Japanese	*: Others

B Signal type/data

LPCM/PPCM/□□ Digital/DTS/MPEG: Signal type

k (kHz): Sampling frequency

b (bit): Number of bits

ch (channel): Number of channels

Example: 3/2 .1ch

- └ L .1: Subwoofer signal
(not displayed if there is no subwoofer signal)
- └ 0: No surround
- └ 1: Mono surround
- └ 2: Stereo surround (left/right)
- └ 1: Center
- └ 2: Front left+ Front right
- └ 3: Front left+ Front right+ Center

Audio Menu

e.g. DVD-Video



- a) **Advanced Surround (VSS)** **RAM** **DVD-V** **VCD**
SP: (Dolby Digital, DTS, LPCM, 2-channel or over only)

HP: (Dolby Digital, LPCM, 2-channel or over only)

Use Advanced Surround to enjoy a surround-like effect if you are using 2 front speakers (SP) or headphones (HP). (To enjoy HP-VSS, connect the unit to equipment that has a headphone jack.) If you are playing a disc with surround effects recorded on it, the effect is broadened and sound seems to come from virtual speakers on either side.

• **VSS mode:** SP ↔ HP

• **SP/HP level:** 1 (Natural effect) ↔ 2 (Emphasized effect)
↕ OFF (Cancel: Factory preset) ↕

To change SP/HP level:

[▶] = [▲, ▼]



Optimum seating position

<When using the television's speakers>

Distance A =

Television's width

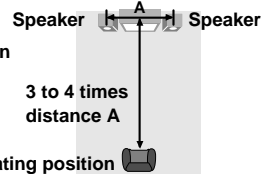

Seating position

Note

- Advanced Surround will not work, or will have less effect with some discs.
- Turn off the surround sound effects on the equipment you have connected when using this effect.
- Turn Advanced Surround off if it causes distortion.
- Even if three or more speakers are connected, output from this unit will be in stereo (two channels) when Advanced Surround is on.
- Turn Advanced Surround off when using Dolby Pro Logic. Dolby Pro Logic will not work correctly if it is on.

- b) **Dialogue Enhancer** **DVD-V**
(Dolby Digital/DTS, 3-channel or over, where the dialogue is recorded in the center channel)

This makes the dialogue in movies easier to hear.

ON ↔ OFF

Note

Dialogue Enhancer will not work or will have less effect with some discs.



Display Menu

e.g. DVD-Video

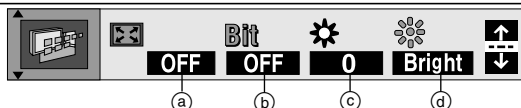

- a) **4:3 TV ZOOM** **RAM** **DVD-A** **DVD-V** (→ page 15)

ON ↔ OFF

- b) **Bitrate display** **RAM** **DVD-A** **DVD-V** **VCD**

Displays the bitrate (approximate values) and type of picture

(→ page 25, Glossary—I/P/B)

ON ↔ OFF

To change the bitrate display: [◀, ▶]

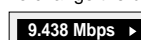

• During play: shows the average bitrate of the video being played

While paused: shows the data volume of the frame



• A record of bitrates for a sampling period.

Current bitrate | Bitrate record
Average bitrate

- c) **OSD Brightness** (-3 to +3)

Adjust the brightness of the on-screen displays.

- d) **FL Dimmer** **RAM** **DVD-A** **DVD-V** **VCD** **CD** **WMA** **MP3**

Changes the brightness of the unit's display.

Bright ↔ Dim ↔ Auto* (**RAM** **DVD-A** **DVD-V** **VCD**)

*The display is dimmed during play, but brightens when you perform operations such as slow-motion, search, and pause.

Unit information

RAM DVD-A DVD-V VCD

Picture Menu

When PROGRESSIVE OUT indicator is on

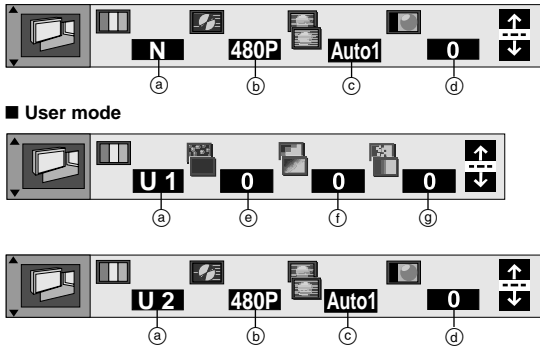

When PROGRESSIVE OUT indicator is off

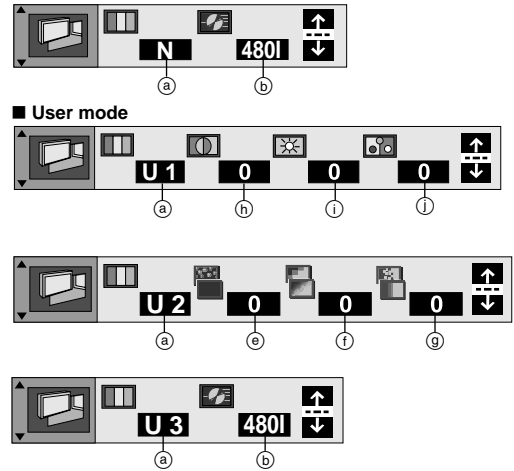

a **Picture Mode**

- **N**: Normal mode
 - **C1** (Cinema 1): Mellows images and enhances detail in dark scenes
 - **C2** (Cinema 2): Sharpens images and enhances detail in dark scenes
 - **U1/U2/U3***: User mode (→ right)
- *U3 appears only when PROGRESSIVE OUT indicator is off.

b **Video Output Mode**

- (→ page 25, Glossary—Interlace and progressive output)
- 480I**: Interlace video (PROGRESSIVE OUT indicator off)
 - 480P**: Progressive video (PROGRESSIVE OUT indicator on)
- You can change the video output mode only when "Progressive Out" in the Video menu is set to "Enable" (→ page 21).

c **Transfer Mode**

- Select the method of conversion for progressive output to suit the type of material being played (→ page 25, Glossary—Film and video).
- **Auto 1 (normal)**: for viewing film material
 - **Auto 2**: for viewing film material (the same as Auto 1, but able to convert 30-frame-per-second progressive video)
 - **Video**: for video material

d **H Position** (Horizontal position) (–20 to +20)

- Change the picture's position if it is off center.
1. Press [ENTER].
 2. Press [◀, ▶] to move the picture.
 3. Press [ENTER] to enter the position (saved even if you turn the unit off).

■ User mode

To change the user mode

1. Select User mode and press [▶] to highlight the number.
2. Press [▲, ▼] to select "1", "2" or "3".



—MPEG Digital Noise Reduction—

- e** **3D-NR** (0 to +4)
Reduces overall noise.
- f** **Block NR** (0 to +3)
Smooths block noise.
- g** **Mosquito NR** (0 to +3)
Reduces the smudging that appears around contrasting sections of the picture.

—Picture Control—

- h** **Contrast** (–7 to +7)
Increases the contrast between light and dark parts of the picture.
- i** **Brightness** (0 to +15)
Brightens the picture.
- j** **Color** (–7 to +7)
Adjust the shade of the picture's color.

Progress indicator

Indicates how far you have played through an item.

e.g. DVD-Video

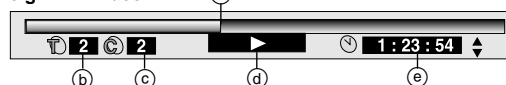

a **Current position** RAM DVD-A DVD-V VCD CD WMA MP3

b **PG: Program number** RAM

PL: Play list number RAM

T: Title number DVD-V

Track number VCD CD

G: Group number DVD-A WMA MP3

c **T: Track number in group** DVD-A WMA MP3

C: Chapter number DVD-V

d **Condition – play, pause, or slow/search**

RAM DVD-A DVD-V VCD CD WMA MP3

e **Changing the time display** RAM DVD-A DVD-V VCD CD





Press [▲, ▼] to show the elapsed play time or remaining time for the program, track or title (or chapter during program and random play).

Elapsed play time WMA MP3

(display only, cannot be changed)

Changing settings

This chart shows the settings for this unit. Change the settings to suit your preferences and to suit the unit to the environment in which it is being used. These settings are retained in memory until they are changed, even if the unit is turned off. See page 22 for details on menu operation.

Menus	Items	Options (Underlined items are the factory preset.)
Disc 	Audio Choose the audio language.	<u>English</u> French Spanish Original* ¹ Other *** ²
	Subtitle Choose the subtitle language.	<u>Automatic</u> ³ English French Spanish Other **** ²
	Menus Choose the language for disc menus.	<u>English</u> French Spanish Other *** ²
	Ratings Set a ratings level to limit DVD-Video play. ● The password screen is shown if you choose levels 0 to 7 or if you choose "Ratings" when levels 0 to 7 have been selected (⇒ page 22). ● Select "Level 0" to prevent play of discs that do not have ratings levels recorded on them.	Setting ratings (When level 8 is selected) <u>8 No Limit</u> 1 to 7 ⁴ 0 Lock All <hr/> Changing ratings (When level 0–7 is selected) Unlock Player Change Password Change Level Temporary Unlock
Video 	TV Aspect (⇒ page 9) Choose the setting to suit your television and preference.	<u>4:3 Pan&Scan</u> 4:3 Letterbox 16:9
	Progressive Out Choose "Enable" to enable progressive output.	<u>Disable</u> Enable
	Still Mode (⇒ page 25, Glossary—Frame still and field still) Specify the type of picture shown when paused.	<u>Automatic</u> Field Frame
	Black Level Control Change the black level of the picture if you connected a television through the COMPONENT VIDEO OUT terminals.	<u>Lighter</u> : when connected to a TV through the VIDEO OUT or S VIDEO OUT terminal. Darker: when connected to a TV through the COMPONENT VIDEO OUT (Y/Pb/Pr) terminals.
Audio 	Speaker Setting (⇒ page 23) Choose the settings to suit your audio system and the listening environment.	<u>Multi-channel</u> : when 3 or more speakers are connected. ● Speaker presence and size ● Delay time ● Channel balance <hr/> 2-channel: when 2 speakers or an amplifier with a Dolby Pro Logic decoder is connected.
	Digital Audio Output Select whether to output digital signals or not.	<u>On</u> : Digital signals are output. Off: Digital signals are not output. This improves sound quality when you are using analog connection.
	PCM Down Conversion (⇒ page 23)	<u>No</u> Yes
	Dolby Digital (⇒ page 23)	<u>Bitstream</u> PCM
	DTS Digital Surround (⇒ page 23)	<u>PCM</u> Bitstream
	Dynamic Range Compression (Dolby Digital only) (⇒ page 25, Glossary) Change the dynamic range for late night viewing.	<u>Off</u> On
	Audio during Search ⁵ Choose whether to have sound during search.	<u>On</u> Off
	Display 	Menu Language Choose the language for these menus and the on-screen messages.
On-Screen Messages Choose whether to show on-screen messages or not.	<u>On</u> Off	
Others 	DVD-Video Mode Select how to play pictures contained on some DVD-Audio. The setting returns to "Off" when you change the disc or turn the unit off.	<u>Off</u> : DVD-Audio are played as DVD-Audio. On: DVD-Video contents found on DVD-Audio can be played.
	Demo A demonstration of the unit's on-screen displays starts when you select "On". The demonstration stops when you press a button and the setting reverts to "Off".	<u>Off</u> On
	QUICK SETUP (⇒ page 9) Answer questions to make basic settings.	Yes <u>No</u>

*¹ The original language of each disc will be selected.

*² Input a code number with the numbered buttons (⇒ page 22).

*³ If the language selected for "Audio" is not available, subtitles of that language will automatically appear if available on that disc.

*⁴ Prohibits play of DVD-Video with corresponding ratings recorded on them.

*⁵ The feature doesn't work for WMA files and DTS-CD discs. Audio will be heard when playing some DVD-Audio despite the settings you make here.

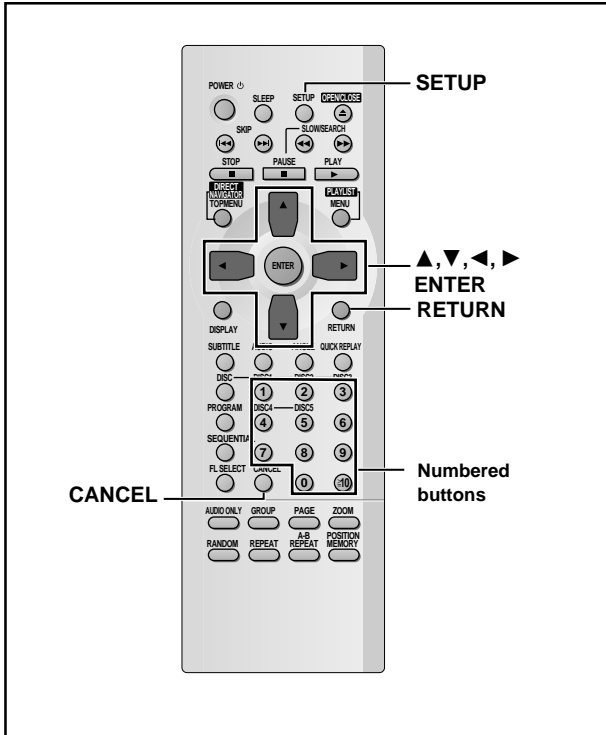

Common procedures

See page 21 for menu and option details.

1 Press [SETUP] to show the menus.

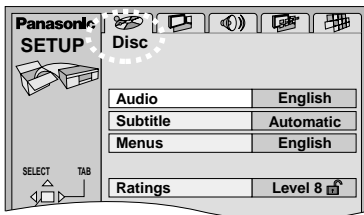

- The QUICK SETUP screen appears when you press [SETUP] the first time after purchase (→ page 9).

2 Press [◀, ▶] to select the menu's tab.

The screen changes to display the menu.

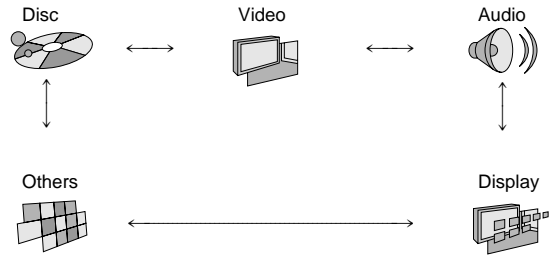

3 Press [▲, ▼] to select the item you want to change and press [ENTER].

4 Press [▲, ▼] to select the option and press [ENTER].

The screen now shows the menu again.

To return to the previous screen

Press [RETURN].

To exit the SETUP menu

Press [SETUP].

Entering a password (Ratings)

DVD-V

The password screen is shown when you select levels 0 to 7.

- Input a 4-digit password with the numbered buttons.
 - If you enter a wrong number, press [CANCEL] to erase it.
- Press [ENTER].
 - The lock symbol appears closed to show the rating is locked.
 - **Do not forget your password.**
- Press [ENTER] to confirm the 4 digits.

Now, when you insert a DVD-Video that exceeds the ratings limit you set, a message appears on the television. Follow the on-screen instructions.

Language code list

Abkhazian: 6566	Byelorussian: 6669	Georgian: 7565	Kazakh: 7575	Nauru: 7865	Serbian: 8382	Tibetan: 6679
Afar: 6565	Cambodian: 7577	German: 6869	Kirghiz: 7589	Nepali: 7869	Serbo-Croatian: 8372	Tigrinya: 8473
Afrikaans: 6570	Catalan: 6765	Greek: 6976	Korean: 7579	Norwegian: 7879	Shona: 8378	Tonga: 8479
Albanian: 8381	Chinese: 9072	Greenlandic: 7576	Kurdish: 7585	Oriya: 7982	Sindhi: 8368	Turkish: 8482
Ameharic: 6577	Corsican: 6779	Guarani: 7178	Laotian: 7679	Pashto, Pushto: 8083	Singhalese: 8373	Turkmen: 8475
Arabic: 6582	Croatian: 7282	Hausa: 7265	Latin: 7665	Persian: 7065	Slovak: 8375	Twi: 8487
Armenian: 7289	Czech: 6783	Hebrew: 7387	Latvian, Lettish: 7686	Polish: 8076	Slovenian: 8376	Ukrainian: 8575
Assamese: 6583	Danish: 6865	Hindi: 7273	Lingala: 7678	Portuguese: 8084	Somali: 8379	Urdu: 8582
Aymara: 6588	Dutch: 7876	Hungarian: 7285	Lithuanian: 7684	Punjabi: 8065	Spanish: 6983	Uzbek: 8590
Azerbaijani: 6590	English: 6978	Indonesian: 7378	Macedonian: 7775	Quechua: 8185	Sundanese: 8385	Vietnamese: 8673
Bashkir: 6665	Esperanto: 6979	Interlingua: 7365	Malay: 7783	Rhaeto-Romanche: 8277	Swahili: 8387	Volapük: 8679
Basque: 6985	Estonian: 6984	Irish: 7165	Malayalam: 7776	Romanian: 8279	Swedish: 8386	Welsh: 6789
Bengali; Bangla: 6678	Faroese: 7079	Italian: 7384	Maltese: 7784	Russian: 8285	Tagalog: 8476	Wolof: 8779
Bhutani: 6890	Fiji: 7074	Japanese: 7465	Maori: 7773	Samoan: 8377	Tamil: 8465	Xhosa: 8872
Bihari: 6672	Finnish: 7073	Javanese: 7487	Marathi: 7782	Sanskrit: 8365	Tatar: 8484	Yiddish: 7473
Breton: 6682	French: 7082	Kannada: 7578	Moldavian: 7779	Scots Gaelic: 7168	Telugu: 8469	Yoruba: 8979
Bulgarian: 6671	Frisian: 7089	Kashmiri: 7583	Mongolian: 7778		Thai: 8472	Zulu: 9085
Burmese: 7789	Galician: 7176					

Digital output

DVD-A DVD-V

Change the settings when you have connected equipment through this unit's DIGITAL AUDIO OUT terminal (OPTICAL).

PCM Down Conversion

Select how to output audio with a sampling frequency of 96 kHz or 88.2 kHz.

- Select "Yes" if the equipment you connect cannot process signals with a sampling frequency of 96 kHz or 88.2 kHz.

No (Factory preset): Output as 96 kHz or 88.2 kHz

Yes: Converted to 48 kHz or 44.1 kHz

Note

- Make sure that "Digital Audio Output" setting (⇒ page 21) is "On".
- Signals are converted to either 48 kHz or 44.1 kHz despite the above settings if the signals have a sampling frequency of over 96 kHz, or the disc has copy protection.
- Some equipment cannot handle sampling frequencies of 88.2 kHz, even if they can handle 96 kHz. Read your equipment's operating instructions for details.

Dolby Digital and DTS Digital Surround

Bitstream (Factory preset for Dolby Digital):

Select if the equipment you connected can decode the signal.

PCM (Factory preset for DTS Digital Surround):

Select if the equipment you connected cannot decode the signal.

IMPORTANT

If the equipment you connected cannot decode the signal, the setting must be changed to PCM. If not, signals the equipment cannot process will be output by this unit, causing high levels of noise which can damage your hearing and the speakers.

Speaker setting

Change speaker presence and size (a), delay time (b), and channel balance (c) to suit the speakers you have connected.

These settings are not necessary when you select "2-channel" (only two speakers are connected).

Note

This feature works only for analog connection (⇒ page 7).

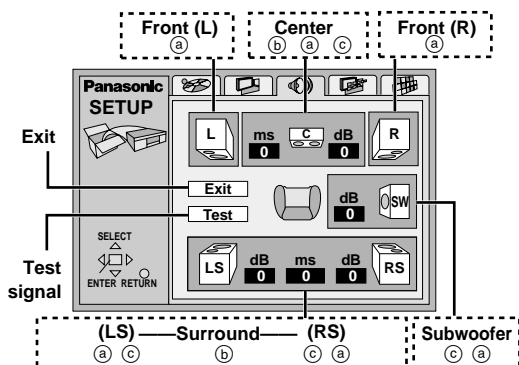

Speaker presence and size (a)

1. Press [**▲**, **▼**, **◀**, **▶**] to select the item and press [ENTER].
2. Press [**▲**, **▼**] to select the setting and press [ENTER].

Icon examples:

Surround speaker (LS)



No



Large



Small

- Large**: When the speaker supports low-frequency (under 100 Hz) reproduction.
- Small**: Select when the speaker does not support low-frequency reproduction.

If the subwoofer is set to No, the front speakers will automatically be set to Large.

Delay time (b)

DVD-V (Dolby Digital and DTS, center and surround speakers only)

For optimum listening with 5.1-channel sound, all the speakers, except for the subwoofer, should be the same distance from the seating position. If you have to place the center or surround speakers closer to the seating position, adjust the delay time to make up for the difference.

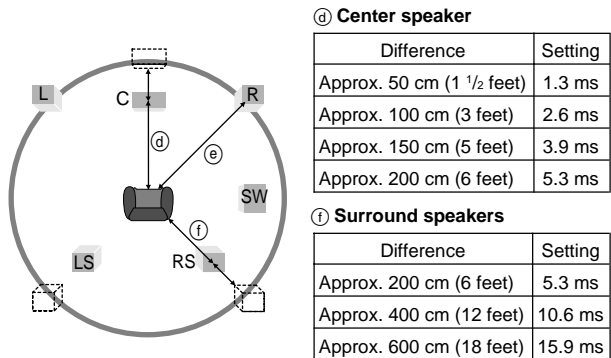

If distances (d) (from the center speaker) and (f) (from the surround speakers) are the same as or greater than (e) (from the front speakers), leave the delay time as "0", the factory preset.

If either distance (d) or (f) is less than (e), find the difference in the relevant table and change to the recommended setting.

Changing the delay time

1. Press [**▲**, **▼**, **◀**, **▶**] to select the delay time box and press [ENTER].
2. Press [**▲**, **▼**] to adjust the delay time and press [ENTER].

Channel balance (c)

1. Press [**▲**, **▼**, **◀**, **▶**] to select "Test" and press [ENTER].

A test signal is output from one speaker at a time, starting with the front left speaker and proceeding clockwise.

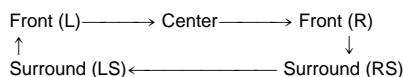

2. While listening to the test signal, press [**▲**, **▼**] to adjust the volume of the center and surround speakers so they are the same apparent volume as the front speakers (-6 to +6). (The front speakers cannot be adjusted here.)

3. Press [ENTER].

The test signal stops.

- No signal is output for the subwoofer. To adjust its volume, play something, then return to this screen to adjust to suit your taste.

To finish the speaker setting

Press [**▲**, **▼**, **◀**, **▶**] to select "Exit" and press [ENTER].

Note

The unit may be unable to output as set here due to limitations imposed by the unit itself or the disc being played. (The display's "D.MIX" indicator goes out in these cases.)

Troubleshooting guide

Before requesting service, make the below checks. If you are in doubt about some of the check points, or if the remedies indicated in the chart do not solve the problem, **contact the Panasonic Customer Call Center at 1-800-211-7262, or e-mail consumerproducts@panasonic.com, or web site (<http://www.panasonic.com>).**

Power

Page

No power.	<ul style="list-style-type: none"> ● Insert the AC power supply cord securely into the household AC outlet. 	6
The unit is automatically switched to the standby mode.	<ul style="list-style-type: none"> ● To conserve power, the unit automatically switches to standby after approximately 30 minutes in the stop mode. Turn the power back to ON. ● The unit was switched to standby by the SLEEP timer. 	– 12

Operation

No response when buttons pressed.	<ul style="list-style-type: none"> ● Some operations may be prohibited by the disc. ● The unit may not be operating properly due to lightning, static electricity or some other external factor. <p>Reset procedure: Press [POWER ⏻] to switch the unit to the standby mode and then back to ON. Alternatively, press [POWER ⏻] to switch the unit to the standby mode, disconnect the AC power supply cord, and then reconnect it.</p>	– –
No operations can be performed with the remote control.	<ul style="list-style-type: none"> ● Check that the batteries are installed correctly. ● The batteries are depleted: Replace them with new ones. ● Point the remote control at the remote control signal sensor and operate. 	8 8 8
Play doesn't start (or stops immediately) when you press [▶] (PLAY).	<ul style="list-style-type: none"> ● Condensation has formed: Wait 1 to 2 hours for it to evaporate. ● This unit cannot play discs other than the ones listed in these operating instructions. ● You can only play DVD-Video if their region number is "1", "ALL" or multiple region number including "1". ● The disc may be dirty and require cleaning. ● Ensure that the disc is installed with the label of the side to be played facing upwards. ● Check that the DVD-RAM has something recorded on it. 	– 5 Cover 5 9 –
Cannot play DVD-Video.	<ul style="list-style-type: none"> ● Sequential Mode is on. Press [SEQUENTIAL] to turn Sequential Mode off. 	10
Cannot select alternative languages.	<ul style="list-style-type: none"> ● This function is dependent on software availability. ● Try selecting from the disc's menu if one is available. 	– 10
No menu play.	<ul style="list-style-type: none"> ● This function is dependent on software availability. 	–
No subtitles.	<ul style="list-style-type: none"> ● This function is dependent on software availability. ● Subtitles are cleared from the television. Display the subtitles. 	– 15
Soundtrack and/or subtitle language is not the one selected with the SETUP menus.	<ul style="list-style-type: none"> ● This function is dependent on software availability. 	–
Cannot change angle.	<ul style="list-style-type: none"> ● This function is dependent on software availability. Even if a disc has a number of angles recorded, these angles may be recorded for specific scenes only. 	–
Dialogue Enhancer has no effect.	<ul style="list-style-type: none"> ● This feature does not work when the unit is outputting bitstream signals. 	–
You have forgotten your ratings password. Reset all the settings to Factory Preset.	<ul style="list-style-type: none"> ● While stopped, press and hold [◀◀] and [] on the unit and then also press and hold [▲] on the unit until "Initialized" disappears from the television. Turn the unit off and on again. All settings will return to the default values. 	–
The drawer stops while opening.	<ul style="list-style-type: none"> ● If possible, remove the discs at the front of the drawer, then turn the unit off and back on again. 	–
The progressive out indicator does not light.	<ul style="list-style-type: none"> ● Go to Video in the SETUP menus, and select "Enable" in "Progressive Out". 	21

Picture

Picture distorted.	<ul style="list-style-type: none"> ● Some distortion is normal during SEARCH. ● The screen may be disrupted briefly when you turn off the AUDIO ONLY feature. ● If "This disc is PAL system. The output is sound only." is on the television, then you have loaded a PAL system DVD-Audio and only the audio portion of the disc can be played. 	– – –
No picture.	<ul style="list-style-type: none"> ● Check the connection. ● Make sure the television is on. ● Ensure the television's video input setting (e.g., VIDEO 1) is correct. 	6 – –
The picture shown on the television is not normal. (The sides of the picture are cut off, the picture is stretched horizontally, or black bands appear at the top and bottom of the screen.)	<ul style="list-style-type: none"> ● Go to Video in the SETUP menus, and change "TV Aspect" to suit your television. ● Use the television to change the aspect to the correct one. ● If your television cannot change the aspect when input is progressive, press [PROGRESSIVE OUT] so the indicator goes out. Output will now be interlace. ● The 4:3 TV ZOOM function is on. ● Ensure that the unit is connected directly to the television, and is not connected through a video cassette recorder. ● Connect to the component video (480P) input terminals on a television compatible with this unit's copy guard system. You cannot view progressive video if your television is not compatible. 	9, 21 9 15 6 6
There is ghosting when progressive output is on.	<ul style="list-style-type: none"> ● Press [PROGRESSIVE OUT] so the indicator goes out. This problem is caused by the editing method or material used on DVD-Video, but should be corrected if you use interlace output. 	9
Picture quality is poor.	<ul style="list-style-type: none"> ● Check the settings in the On-Screen Menu Icons' Picture Menu. 	20
The picture is off center when progressive output is on.	<ul style="list-style-type: none"> ● Adjust the horizontal position in the On-Screen Menu Icons' Picture Menu. 	20

Sound		Page
No sound. Distorted sound.	●Check the connections.	6, 7
	●Check the volume on the equipment you have connected.	–
	●Ensure that the input settings on the other equipment are correct.	–
	●Turn Advanced Surround off if it causes distortion.	19
	●Output from this unit will be in stereo (two channels) when Advanced Surround is on. Turn Advanced Surround off if you are using three or more speakers.	19
	●If you have connected this unit to an amplifier through the AUDIO OUT terminals, go to the Audio menu in the SETUP menu, and change “Speaker setting” to suit to your speakers. Select the large or small icon for all the speakers you have connected.	23
Piercing noise comes from the speakers.	●Due to the specifications on some types of televisions, both video and audio may be cut off when you turn the AUDIO ONLY feature on.	–
	●If the “D.MIX” indicator on the display goes out while playing a multi-channel DVD-Audio disc, sound will only be output from speakers specified by the disc. Read the disc’s instructions for details.	–
	●If you have connected this unit to other equipment through the DIGITAL AUDIO OUT terminal, ensure you have selected the correct settings for “Dolby Digital” and “DTS Digital Surround” in the SETUP menus’ Audio menu.	23

Unit displays

“NoPLAY”	●You inserted a disc the unit cannot play; insert one it can. ●You inserted a blank DVD-RAM.	5 –
“CHECK”	●Disc is dirty: Wipe it clean.	5
“H□□” □□ stands for a number.	●Trouble may have occurred. The number following “H” depends on the status of the unit. Reset procedure: Press [POWER ⏻] to switch the unit to the standby mode and then back to ON. Alternatively, press [POWER ⏻] to switch the unit to the standby mode, disconnect the AC power supply cord, and then reconnect it. ●If the service numbers fail to clear, note the service number and contact a qualified service person.	– –

Television displays

“The progressive out is set to “Disable””	●Go to Video in the SETUP menus, and select “Enable” in “Progressive Out”.	21
“The software has a 4:3 aspect ratio”	●Use the television to change the aspect to the correct one. If your television cannot change the aspect when input is progressive, press [PROGRESSIVE OUT] so the indicator goes out. Output will now be interlace.	9
No on-screen display.	●Go to Display in the SETUP menu, and select “On” for “On-Screen Messages”.	21
On-screen displays (including On-Screen Menu Icons and disc type information screen) not displayed or only partially displayed on the television.	●Press [DISPLAY], and press [◀, ▶] to highlight the Bar Position icon, then press [▲, ▼] to adjust the position.	18
The disc’s menu is displayed in a different language.	●Go to Disc in the SETUP menus, and select the preferred language for “Menus”.	21

Glossary

Bitstream

This is the digital form of multi-channel audio data (e.g., 5.1 channel) before it is decoded into its various channels.

Decoder

A decoder restores the coded audio signals on DVDs to normal. This is called decoding.

Dolby Digital

This is a method of coding digital signals developed by Dolby Laboratories. Apart from stereo (2-channel) audio, these signals can also be multi-channel audio. A large amount of audio information can be recorded on one disc using this method.

Dolby Pro Logic

A surround system where a 4-channel audio track is recorded as 2 channels and then is restored to 4 channels for play. The surround channel is monaural and can reproduce up to 7 kHz.

DTS (Digital Theater Systems)

This surround system is used in many movie theaters around the world. There is good separation between the channels, so realistic sound effects are possible.

Dynamic range

Dynamic range is the difference between the lowest level of sound that can be heard above the noise of the equipment and the highest level of sound before distortion occurs.

Film and video

DVD-Videos are recorded using either film or video. Usually, film is recorded at 24 frames per second, the rate movies are filmed at, while video is recorded at 30 frames per second.

Frame still and field still

Frames are the still pictures that go together to make a moving picture. There are about 30 frames shown each second. One frame is made up of two fields. A regular television shows these fields

one after the other to create frames.

A still is shown when you pause a moving picture. A frame still is made up of two alternating fields, so the picture may appear blurred, but overall quality is high. A field still is not blurred, but it has only half the information of a frame still so picture quality is lower.

Interlace and progressive output

NTSC, the video signal standard, has 480 interlaced (I) scan lines, whereas progressive scanning uses twice the number of scan lines. This is called 480P. The video signals output from this unit’s COMPONENT VIDEO OUT terminals (Y, P_B, P_R) allow you to enjoy higher quality pictures than if the signals were output from the VIDEO OUT terminal or S VIDEO OUT terminal.

I/P/B

MPEG 2, the video compression standard adopted for use with DVD-Video, codes frames using these 3 picture types.

I: Intra coded picture

This picture has the best quality and is the best to use when adjusting the picture.

P: Predictive coded picture

This picture is calculated based on past I or P-pictures.

B: Bidirectionally-predictive coded picture

This picture is calculated by comparing past and future I and P-pictures so it has the lowest volume of information.

Linear PCM (pulse code modulation)

These are uncompressed digital signals, similar to those found on CDs.

Playback control (PBC)

If a Video CD has playback control, you can select scenes and information with menus (called menu play in these instructions).

Limited Warranty

Panasonic Consumer Electronics Company,
Division of Matsushita Electric Corporation of America
One Panasonic Way Secaucus, New Jersey 07094

Panasonic Sales Company, Division of Matsushita Electric
of Puerto Rico, Inc.
Ave. 65 de Infantería, Km. 9.5
San Gabriel Industrial Park, Carolina, Puerto Rico 00985

Panasonic DVD Player/Recorder Limited Warranty

Limited Warranty Coverage

If your product does not work properly because of a defect in materials or workmanship, Panasonic Consumer Electronics Company or Panasonic Sales Company (collectively referred to as "the warrantor") will, for the length of the period indicated on the chart below, which starts with the date of original purchase ("warranty period"), at its option either (a) repair your product with new or refurbished parts, or (b) replace it with a new or a refurbished product. The decision to repair or replace will be made by the warrantor.

Product or Part Name	Parts	Labor
DVD Player	One (1) Year	Ninety (90) Days
DVD Recorder	One (1) Year	One (1) Year
Rechargeable Batteries, DVD-RAM Disc (in exchange for defective item)	Ten (10) Days	Not Applicable

During the "Labor" warranty period there will be no charge for labor. During the "Parts" warranty period, there will be no charge for parts. You must carry-in or mail-in your product during the warranty period. If non-rechargeable batteries are included, they are not warranted. This warranty only applies to products purchased and serviced in the United States or Puerto Rico. This warranty is extended only to the original purchaser of a new product which was not sold "as is". A purchase receipt or other proof of the original purchase date is required for warranty service.

Carry-In or Mail-In Service

For Carry-In or Mail-In Service in the United States call 1-800-211-PANA (7262) or visit Panasonic Web Site: <http://www.panasonic.com>
For assistance in Puerto Rico call Panasonic Sales Company (787)-750-4300 or fax (787)-768-2910.

Limited Warranty Limits And Exclusions

This warranty ONLY COVERS failures due to defects in materials or workmanship, and DOES NOT COVER normal wear and tear or cosmetic damage. The warranty ALSO DOES NOT COVER damages which occurred in shipment, or failures which are caused by products not supplied by the warrantor, or failures which result from accidents, misuse, abuse, neglect, mishandling, misapplication, alteration, faulty installation, set-up adjustments, misadjustment of consumer controls, improper maintenance, power line surge, lightning damage, modification, or commercial use (such as in a hotel, office, restaurant, or other business), rental use of the product, service by anyone other than a Factory Servicenter or other Authorized Servicer, or damage that is attributable to acts of God.

THERE ARE NO EXPRESS WARRANTIES EXCEPT AS LISTED UNDER " LIMITED WARRANTY COVERAGE". THE WARRANTOR IS NOT LIABLE FOR INCIDENTAL OR CONSEQUENTIAL DAMAGES RESULTING FROM THE USE OF THIS PRODUCT, OR ARISING OUT OF ANY BREACH OF THIS WARRANTY. (As examples, this excludes damages for lost time, travel to and from the servicer, loss of media or images, data or other recorded content. The items listed are not exclusive, but are for illustration only.) **ALL EXPRESS AND IMPLIED WARRANTIES, INCLUDING THE WARRANTY OF MERCHANTABILITY, ARE LIMITED TO THE PERIOD OF THE LIMITED WARRANTY.**

Some states do not allow the exclusion or limitation of incidental or consequential damages, or limitations on how long an implied warranty lasts, so the exclusions may not apply to you.

This warranty gives you specific legal rights and you may also have other rights which vary from state to state. If a problem with this product develops during or after the warranty period, you may contact your dealer or Servicenter. If the problem is not handled to your satisfaction, then write to the warrantor's Consumer Affairs Department at the addresses listed for the warrantor.

PARTS AND SERVICE WHICH ARE NOT COVERED BY THIS LIMITED WARRANTY ARE YOUR RESPONSIBILITY.

Customer Services Directory

**For Product Information, Operating Assistance, Literature Request, Dealer Locations, and all Customer Service inquiries please contact:
1-800-211-PANA (7262), Monday-Friday 9 am-9 pm; Saturday-Sunday 9 am-7 pm, EST.**

**Web Site: <http://www.panasonic.com>
You can purchase parts, accessories or locate your nearest servicenter by visiting our Web Site.**

Accessory Purchases:

1-800-332-5368 (Customer Orders Only)
Panasonic Services Company 20421 84th Avenue South, Kent,
WA 98032
(6 am to 5 pm Monday-Friday; 6 am to 10:30 am Saturday; PST)
(Visa, MasterCard, Discover Card, American Express, Check)

Service in Puerto Rico

**Matsushita Electric of Puerto Rico, Inc. Panasonic Sales Company/Factory Servicenter:
Ave. 65 de Infantería, Km. 9.5, San Gabriel Industrial Park, Carolina, Puerto Rico 00985
Phone (787) 750-4300 Fax (787) 768-2910**

Product Service

- 1. Damage requiring service**—The unit should be serviced by qualified service personnel if:
 - (a) The AC power supply cord or AC adaptor has been damaged; or
 - (b) Objects or liquids have gotten into the unit; or
 - (c) The unit has been exposed to rain; or
 - (d) The unit does not operate normally or exhibits a marked change in performance; or
 - (e) The unit has been dropped or the cabinet damaged.
- 2. Servicing**—Do not attempt to service the unit beyond that described in these operating instructions. Refer all other servicing to authorized servicing personnel.
- 3. Replacement parts**—When parts need replacing ensure the servicer uses parts specified by the manufacturer or parts that have the same characteristics as the original parts. Unauthorized substitutes may result in fire, electric shock, or other hazards.
- 4. Safety check**—After repairs or service, ask the servicer to perform safety checks to confirm that the unit is in proper working condition.

Product information

For product information or assistance with product operation:

Contact the Panasonic Customer Call Center at 1-800-211-7262, or e-mail consumerproducts@panasonic.com, or web site (<http://www.panasonic.com>).

Conexión a un televisor

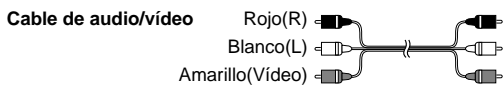

A la toma de CA del hogar
(CA 120 V, 60 Hz)

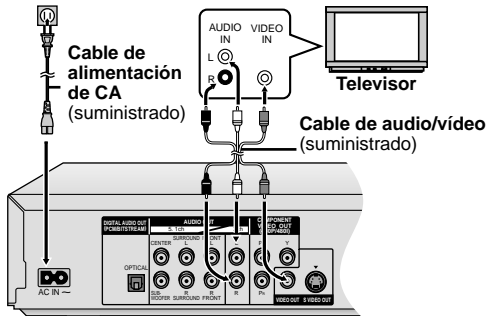

Para disfrutar de vídeo progresivo

Haga la conexión a los terminales de entrada de vídeo componente (480P) de una televisión compatible con el sistema de protección contra el copiado de esta unidad. (La imagen no se verá correctamente si se hace la conexión a una televisión incompatible.)

Preparación Rápida

La pantalla **QUICK SETUP** aparece cuando usted pulsa [SETUP] por primera vez después de adquirir el aparato y le ayuda a efectuar los ajustes necesarios.

- 1 Pulse [POWER] para encender el aparato.
- 2 Pulse [SETUP] para visualizar la pantalla "QUICK SETUP".
- 3 Pulse [▲, ▼] para seleccionar "Español" y pulse [ENTER].
- 4 Pulse [▲, ▼] para seleccionar "Sí" y pulse [ENTER].
- 5 Pulse [▲, ▼] para seleccionar el elemento y pulse [ENTER].
 - Idioma de audio
 - Idioma de los subtítulos
 - Aspecto de su televisor
 - Salida progresiva
 - Altoparlantes
- 6 Pulse [ENTER] y luego [SETUP] para finalizar los ajustes.

● Para volver a la pantalla anterior, pulse [RETURN].

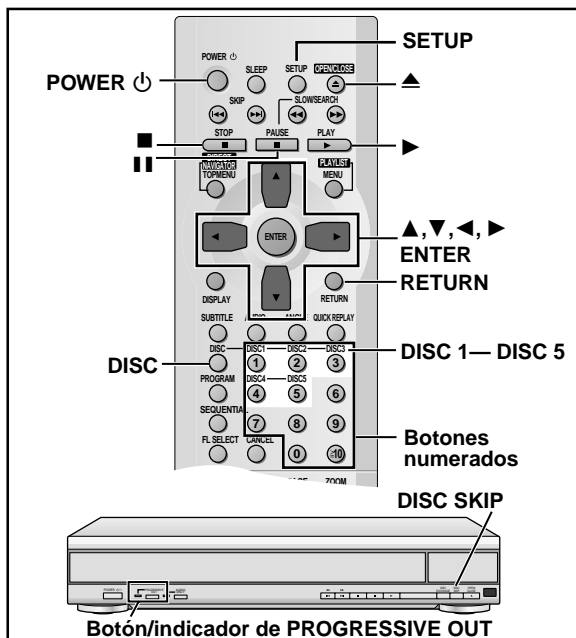

Las operaciones descritas en esta referencia rápida se llevan a cabo con el mando a distancia, pero usted puede hacer también estas operaciones en el aparato principal si los controles son los mismos.

Reproducción básica

RAM DVD-A DVD-V VCD CD WMA MP3

Preparación

Encienda el televisor y seleccione en él la entrada de vídeo apropiada según las conexiones del reproductor.

- 1 Pulse [POWER] para encender el aparato.
Para salida progresiva Pulse [PROGRESSIVE OUT] para que se enciendan los indicadores.
- 2 Pulse [▲] para abrir el cajón.
- 3 Ponga lo(s) disco(s) en la(s) bandeja(s) de disco(s).
Puede cargar discos en las otras bandejas pulsando [DISC SKIP] en el aparato principal.

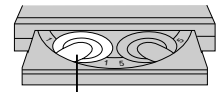

La reproducción empieza desde el disco que se encuentra en la posición delantera izquierda.

- 4 Pulse [▲] para cerrar el cajón.
Si se muestra una pantalla de menú, consulte más abajo.
- 5 Pulse [▶] (PLAY).
La reproducción empieza.

Para detener la reproducción

Pulse [■] (consulte Función de reanudación indicada más abajo).

Para hacer una pausa

Pulse [⏸].
Pulse [▶] (PLAY) para reanudar la reproducción.

Para iniciar la reproducción del disco preferido

1. Pulse [DISC].
2. Pulse el botón de discos ([DISC 1] - [DISC 5]).

Nota

- La salida progresiva no es posible si el ajuste "Salida progresiva" de los menús PREPARACIÓN RÁPIDA se deja en "Desactivar".
- Aunque se encienda el indicador de salida progresiva, si usted pulsa [PROGRESSIVE OUT] después de cambiar el ajuste "Salida progresiva" a "Activar", la salida sólo seguirá intercalándose si usted ha conectado la unidad a su televisor a través de los terminales VIDEO OUT o S VIDEO OUT.

Cuando una pantalla de menús aparece en el televisor

DVD-A DVD-V VCD

Pulse los botones numerados para seleccionar un elemento.

Función de reanudación

Parada-reanudación

El aparato memoriza la posición en la que usted detuvo la reproducción hasta que usted abre la bandeja del disco o pone el aparato en el modo de espera.

Para reanudar la reproducción

Pulse [▶] (PLAY) mientras parpadea "▷" en el visualizador del aparato.

Specifications

Signal system: NTSC
Operating temperature range: +5 to +35 °C (+41 to +95 °F)
Operating humidity range: 5 to 90 % RH (no condensation)

Discs played [8 cm (3 ") or 12 cm (5 ")]:

- (1) DVD-RAM (DVD-VR compatible)
- (2) DVD-Audio
- (3) DVD-Video
- (4) DVD-R (DVD-Video compatible)
- (5) CD-Audio (CD-DA)
- (6) Video CD
- (7) CD-R/CD-RW (CD-DA, Video CD formatted discs)
- (8) WMA/MP3
 - Maximum number of tracks and groups recognizable: 999 tracks and 99 groups
 - Compatible compression rate:
 - WMA: between 48 kbps and 192 kbps
 - MP3: between 32 kbps and 320 kbps

Video output:

Output level: 1 Vp-p (75 Ω)
Output terminal: Pin jack (1 system)

S video output:

Y output level: 1 Vp-p (75 Ω)
C output level: 0.286 Vp-p (75 Ω)
Output terminal: S terminal (1 system)

Component video output (480P/480I):

Y output level: 1 Vp-p (75 Ω)
P_B output level: 0.7 Vp-p (75 Ω)
P_R output level: 0.7 Vp-p (75 Ω)
Output terminal: Pin jack (1 system)
(Y: green, P_B: blue, P_R: red)

Audio output:

Output level: 2 Vrms (1 kHz, 0 dB)
Output terminal: Pin jack
Number of terminal:
2 channel: 1 system
5.1-channel discrete output (5.1 channel): 1 system

Audio performance:

- (1) Frequency response:
 - DVD (linear audio): 4 Hz–22 kHz (48 kHz sampling)
4 Hz–44 kHz (96 kHz sampling)
4 Hz–88 kHz (192 kHz sampling)
 - DVD-Audio: 4 Hz–20 kHz
 - CD audio: 4 Hz–20 kHz
- (2) S/N ratio:
 - CD audio: 115 dB
- (3) Dynamic range:
 - DVD (linear audio): 102 dB
 - CD audio: 98 dB
- (4) Total harmonic distortion:
 - CD audio: 0.0025 %

Digital audio output:

Optical digital output: Optical terminal
Pickup: Wave length: 658 nm/790 nm
Laser power: CLASS IIa/CLASS I

Power supply:

AC 120 V, 60 Hz

Power consumption:

16 W

Dimensions:

430 (W)×406.5 (D)×75.8 (H) mm
[16^{15/16}" (W)×16" (D)×3" (H)]

Mass:

4.5 kg (9.9 lb.)

Power consumption in standby mode: approx. 2.5 W

Note

Specifications are subject to change without notice.
Mass and dimensions are approximate.

Manufactured under license from Digital Theater Systems, Inc. US Pat. No. 5,451,942, 5,956,674, 5,974,380, 5,978,762 and other world-wide patents issued and pending. "DTS" and "DTS Digital Surround" are registered trademarks of Digital Theater Systems, Inc. © 1996, 2000 Digital Theater Systems, Inc. All rights reserved.

Manufactured under license from Dolby Laboratories. "Dolby", "Pro Logic" and the double-D symbol are trademarks of Dolby Laboratories.

Apparatus Claims of U.S. Patent Nos. 4,631,603, 4,577,216, and 4,819,098, licensed for limited viewing uses only.

This product incorporates copyright protection technology that is protected by method claims of certain U.S. patents and other intellectual property rights owned by Macrovision Corporation and other rights owners. Use of this copyright protection technology must be authorized by Macrovision Corporation, and is intended for home and other limited viewing uses only unless otherwise authorized by Macrovision Corporation. Reverse engineering or disassembly is prohibited.

Panasonic Consumer Electronics Company, Division of Matsushita Electric Corporation of America
One Panasonic Way Secaucus,
New Jersey 07094
<http://www.panasonic.com>

Panasonic Sales Company, Division of Matsushita Electric of Puerto Rico, Inc. ("PSC")
Ave. 65 de Infantería, Km. 9.5
San Gabriel Industrial Park, Carolina,
Puerto Rico 00985

